

# INFORMATION ONLY

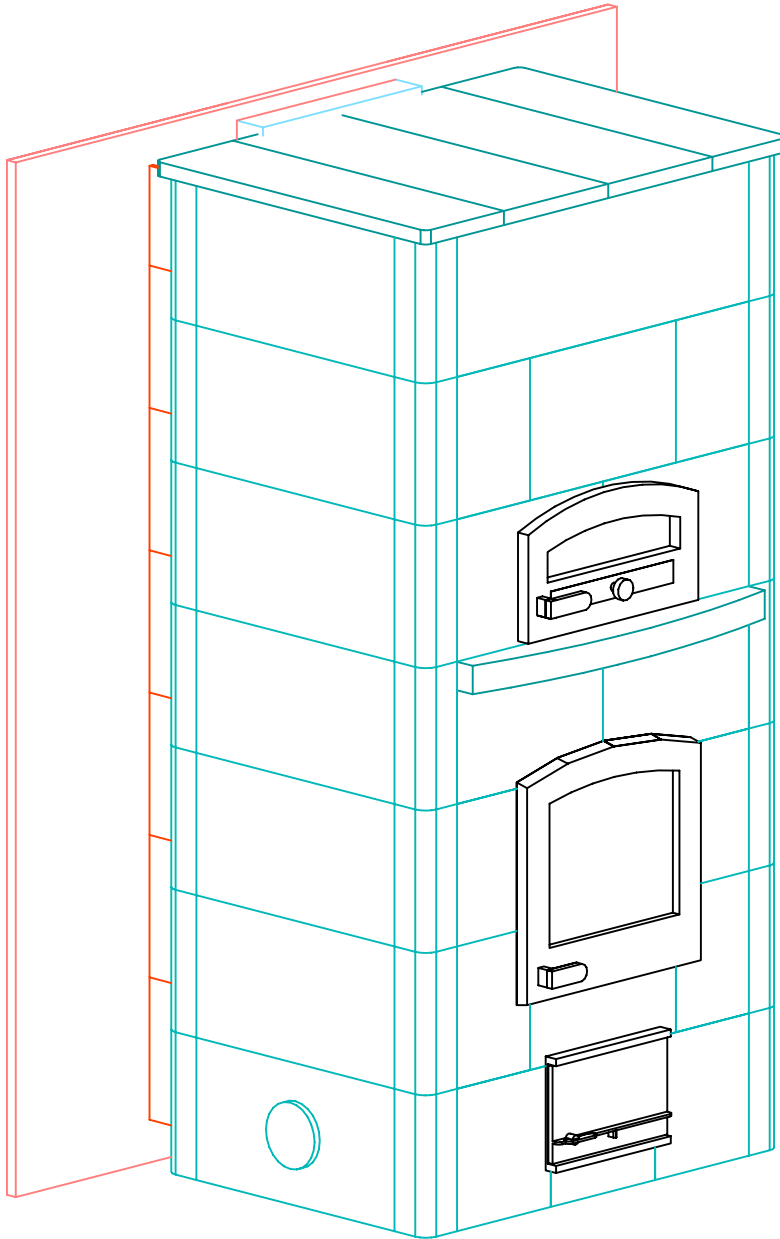

FRONT VIEW

**INFORMATION ONLY**

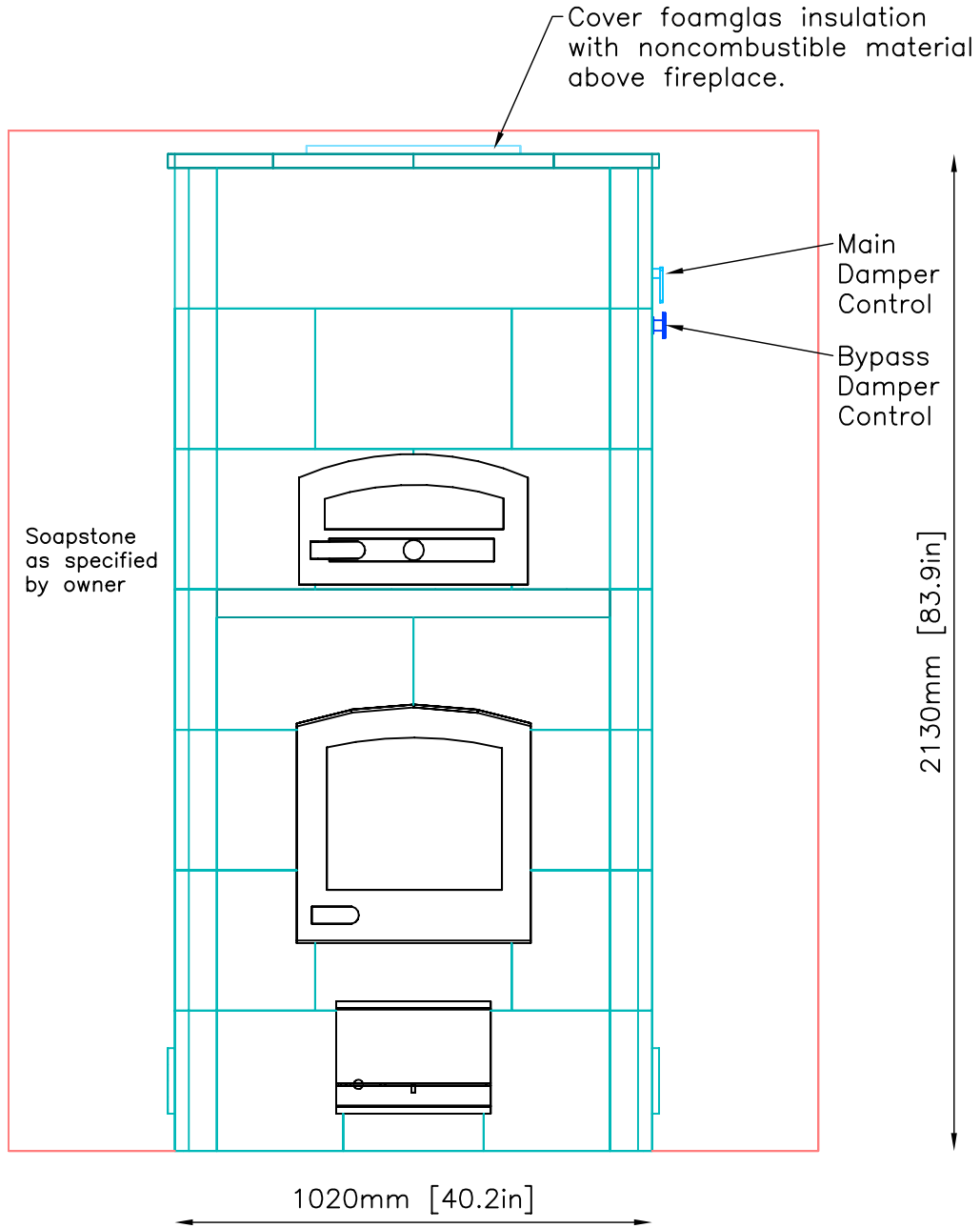

NOTE:  
 NO Combustible Materials WITHIN: 10" of TOP of  
 Fireplace, 14" of SIDES of Fireplace and 20" of  
 BACK of Fireplace.



MID-ATLANTIC MASONRY HEAT  
 1229 Harris Street Suite 1  
 Charlottesville, VA 22903  
 (434)979-9709 Fax 434-979-6416

PROJECT GREEN  
 MODEL TTU2700/5

CONTRACT  
 DRAWN BY D.P.BYRAM

VIEW FRONT  
 DATE 10/28/03

PAGE 2

SIDE VIEW

**INFORMATION ONLY**

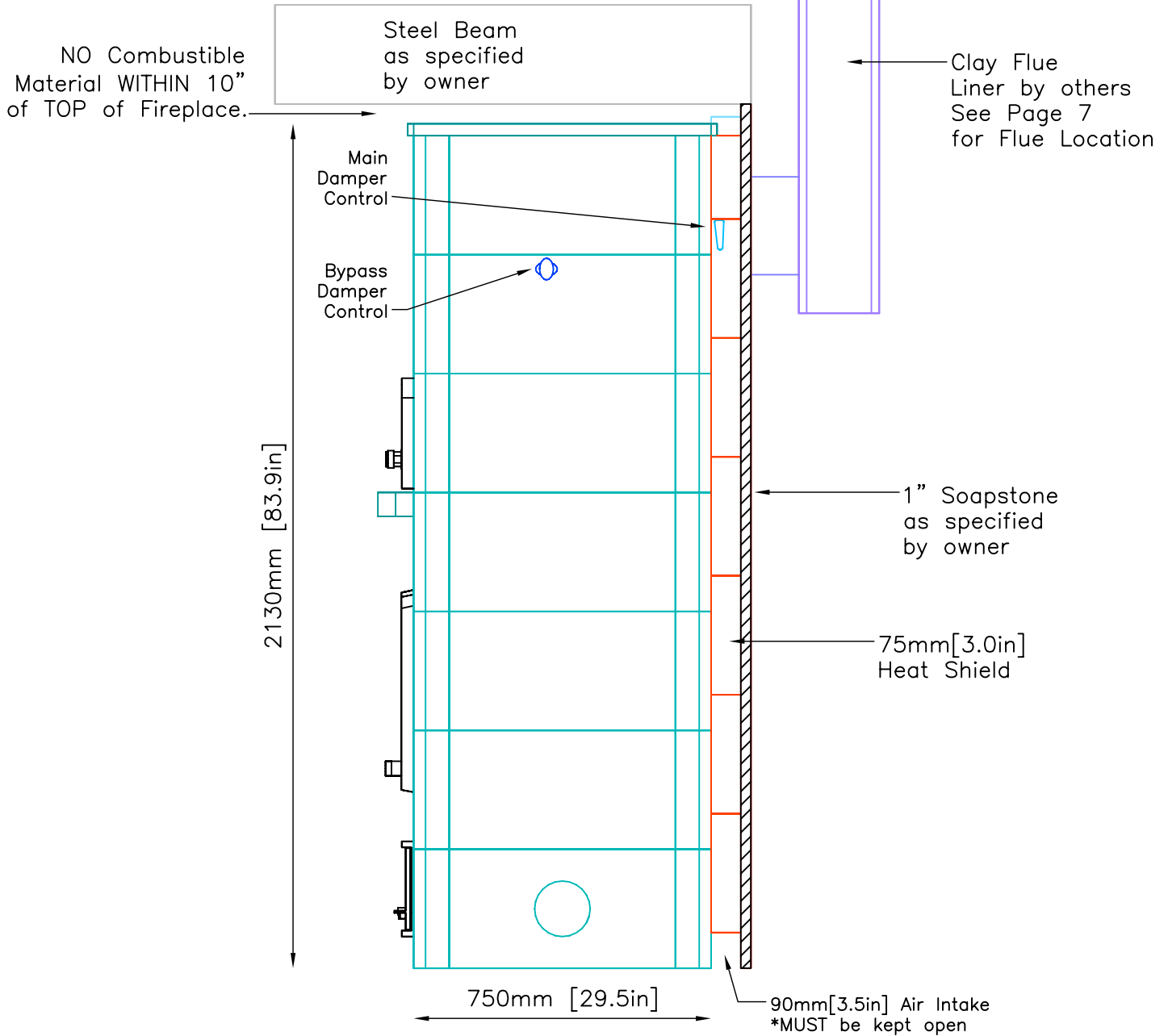

NOTE:  
 NO Combustible Materials WITHIN: 10" of TOP of Fireplace, 14" of SIDES of Fireplace and 20" of BACK of Fireplace.

# INFORMATION ONLY

PLAN VIEW

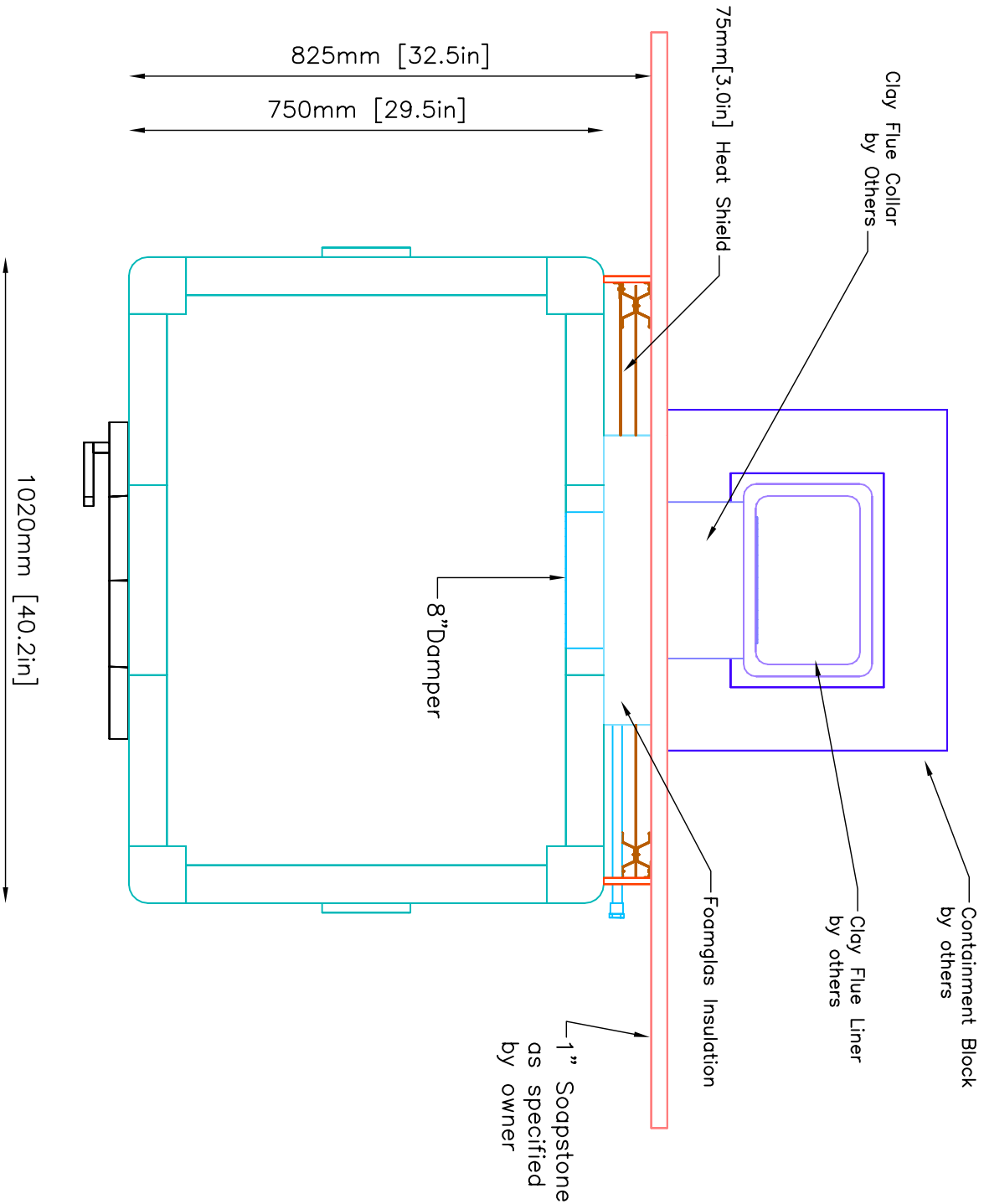

# FOUNDATION SLAB

Minimum 4" Thick Poured Concrete With Rebar 6"O.C.  
 Minimum Dimensions--2" from Base of Unit

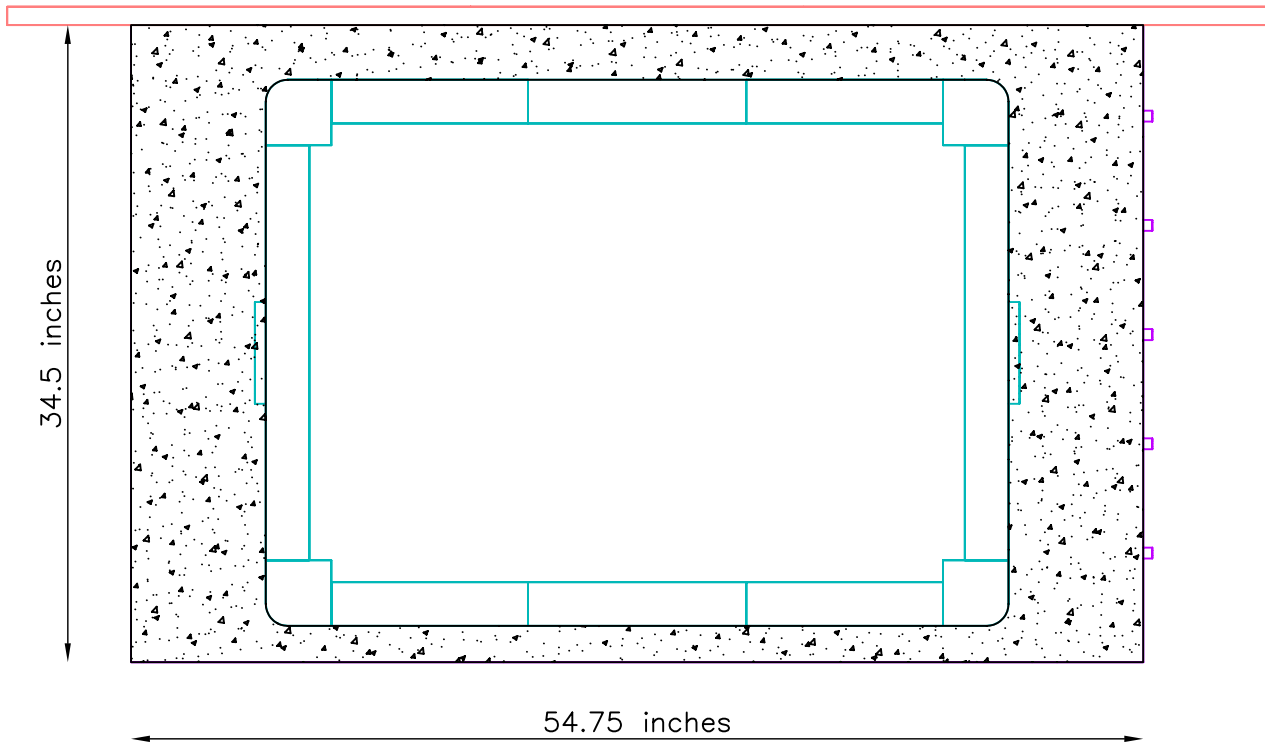

NOTE:  
 TOP OF FOUNDATION SLAB TO BE LEVEL AND FLUSH WITH SUB-FLOOR  
 Tolerances: +/- 1/8" No additional cost to level slab  
 +/- 1/4" \$150.00-\$200.00 additional cost to level slab  
 +/- 1/2" \$500.00 additional cost to level slab

**INFORMATION ONLY**

UNIT WEIGHT: 7000lbs.

Contractor is responsible for engineering foundation slab to support weight of fireplace.

	MID-ATLANTIC MASONRY HEAT 1229 Harris Street Suite 1 Charlottesville, VA 22903 (434)979-9709 Fax 434-979-6416	PROJECT	CONTRACT	VIEW	PAGE
		GREEN MODEL TTU2700/5	DRAWN BY D.P.BYRAM	SUPPORT DATE 10/28/03	5

FOUNDATION SLAB:  
 \* MINIMUM 4" THICK  
 WITH REBAR 6" O.C.  
 \* NONCOMBUSTIBLE  
 CEMENT BOARD  
 under foundation slab  
 (NOT PLYWOOD)

NOTE:  
 TOP OF FOUNDATION SLAB TO BE LEVEL  
 AND FLUSH WITH SUB-FLOOR  
 Tolerances:  
 +/- 1/8" No additional cost to level slab  
 +/- 1/4" \$150.00-\$200.00 additional  
 cost to level slab  
 +/- 1/2" \$500.00 additional  
 cost to level slab

FOUNDATION SLAB:  
 MINIMUM 4" THICK  
 POURED CONCRETE  
 WITH REBAR 6" O.C.  
 NONCOMBUSTIBLE  
 CEMENT BOARD  
 UNDER FOUNDATION  
 SLAB (NOT PLYWOOD)

Footer per Local Code

UNIT WEIGHT: 7000lbs.

Contractor is responsible for engineering foundation slab to support weight of fireplace.

# INFORMATION ONLY

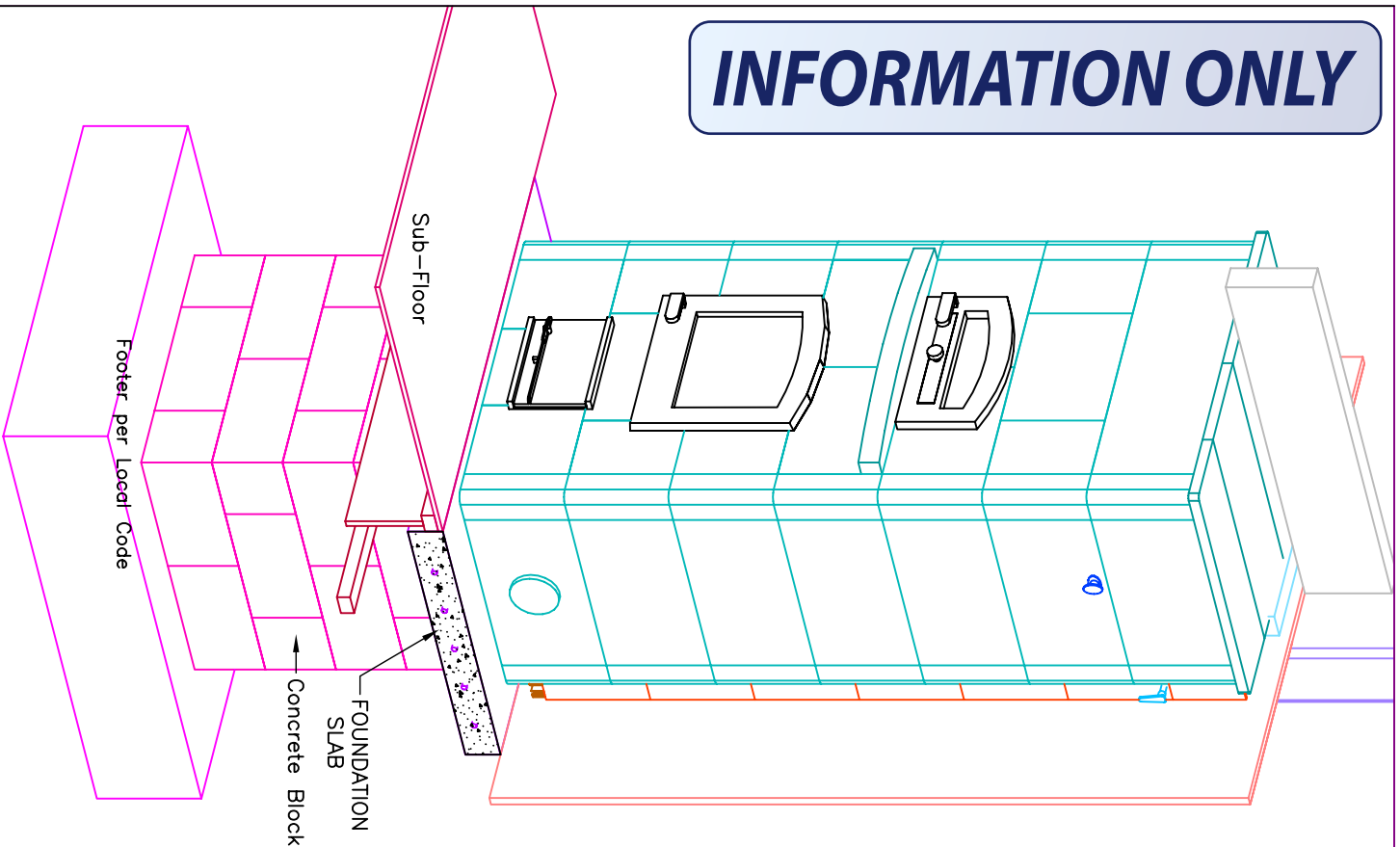

MID-ATLANTIC MASONRY HEAT  
 McIntire Business Park  
 Charlottesville, VA 22903  
 (434)979-9709 Fax 434-979-6416

PROJECT GREEN  
 MODEL TTU2700/5

CONTRACT  
 DRAWN BY D.P. BYRAM

VIEW Foundation Slab  
 DATE 10/28/03

PAGE

6

WALL ELEVATION

**INFORMATION ONLY**

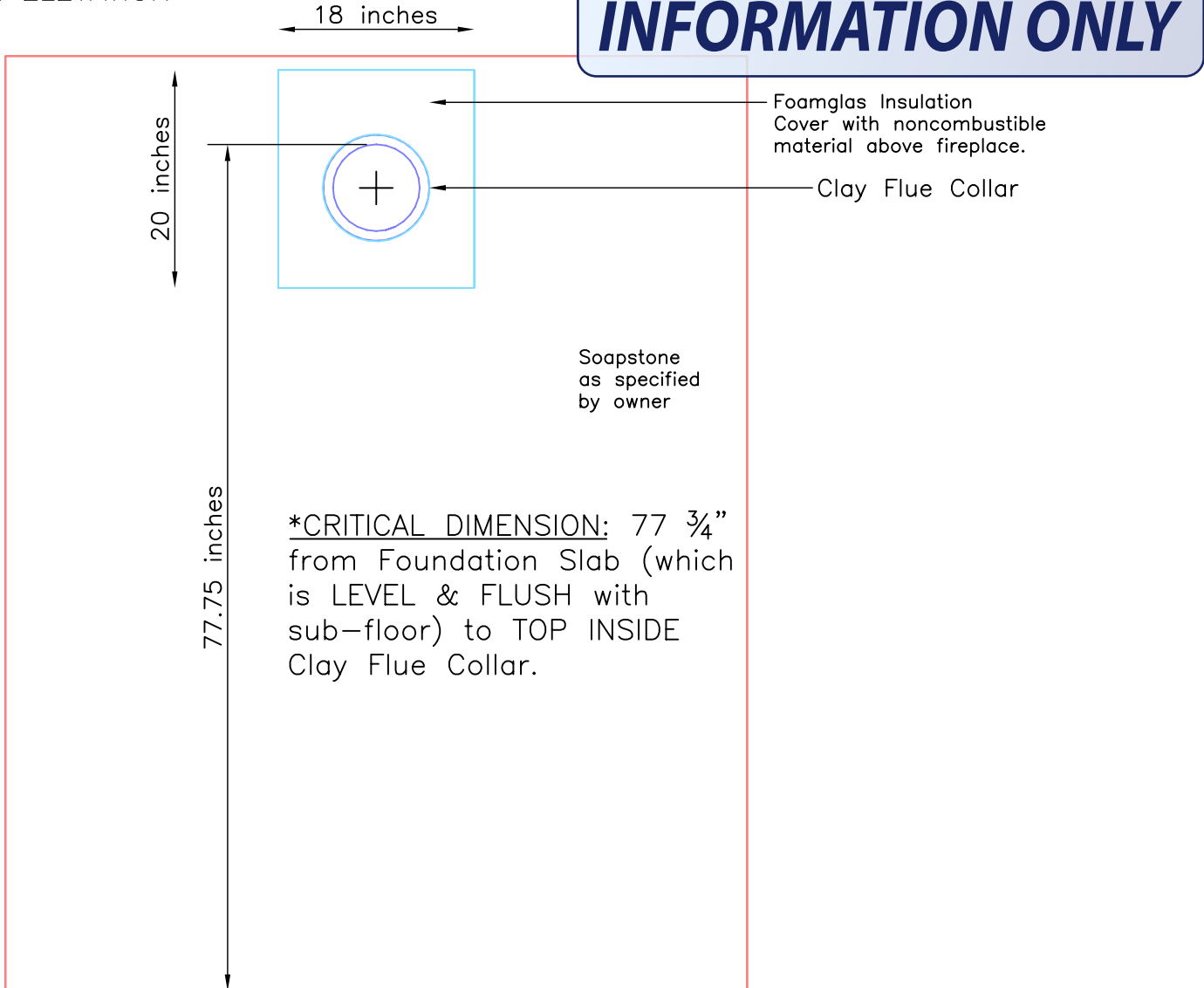

\*CRITICAL DIMENSION: 77 3/4" from Foundation Slab (which is LEVEL & FLUSH with sub-floor) to TOP INSIDE Clay Flue Collar.



**Notes:**  
 Sheetrock behind Fireplace MUST be in place PRIOR to Installation.  
 UL Listed – Minimum Foamglas Insulation 4" on sides & 6" on top of Flue Pipe.  
Chimney Placement  
 \*CRITICAL DIMENSION: 77 3/4" from Foundation Slab (which is LEVEL & FLUSH with sub-floor) to TOP INSIDE Clay Flue Collar.

