

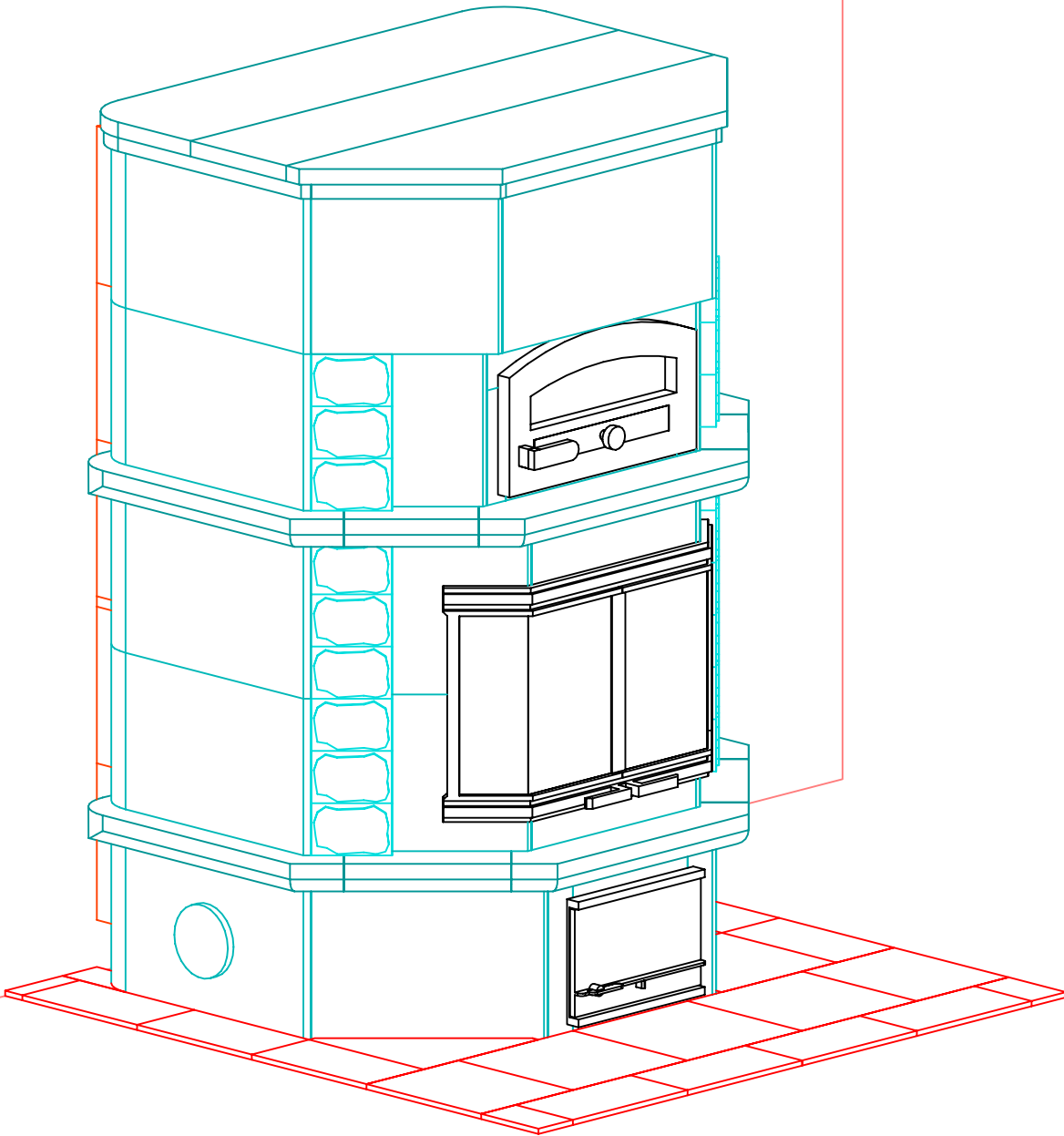

INFORMATION ONLY



NOTE: Hearth Tiles CUT AND INSTALLED by others

	MID-ATLANTIC MASONRY HEAT 1229 Harris Street Suite 1 Charlottesville, VA 22903 (434)979-9709 Fax 434-979-6416	PROJECT	CONTRACT	VIEW	PAGE
		CREATORE	5638	PERSPECTIVE	1
		MODEL	DRAWN BY	DATE	
		TLU2630/1	D.P.BYRAM	3/27/04	

FRONT VIEW

INFORMATION ONLY

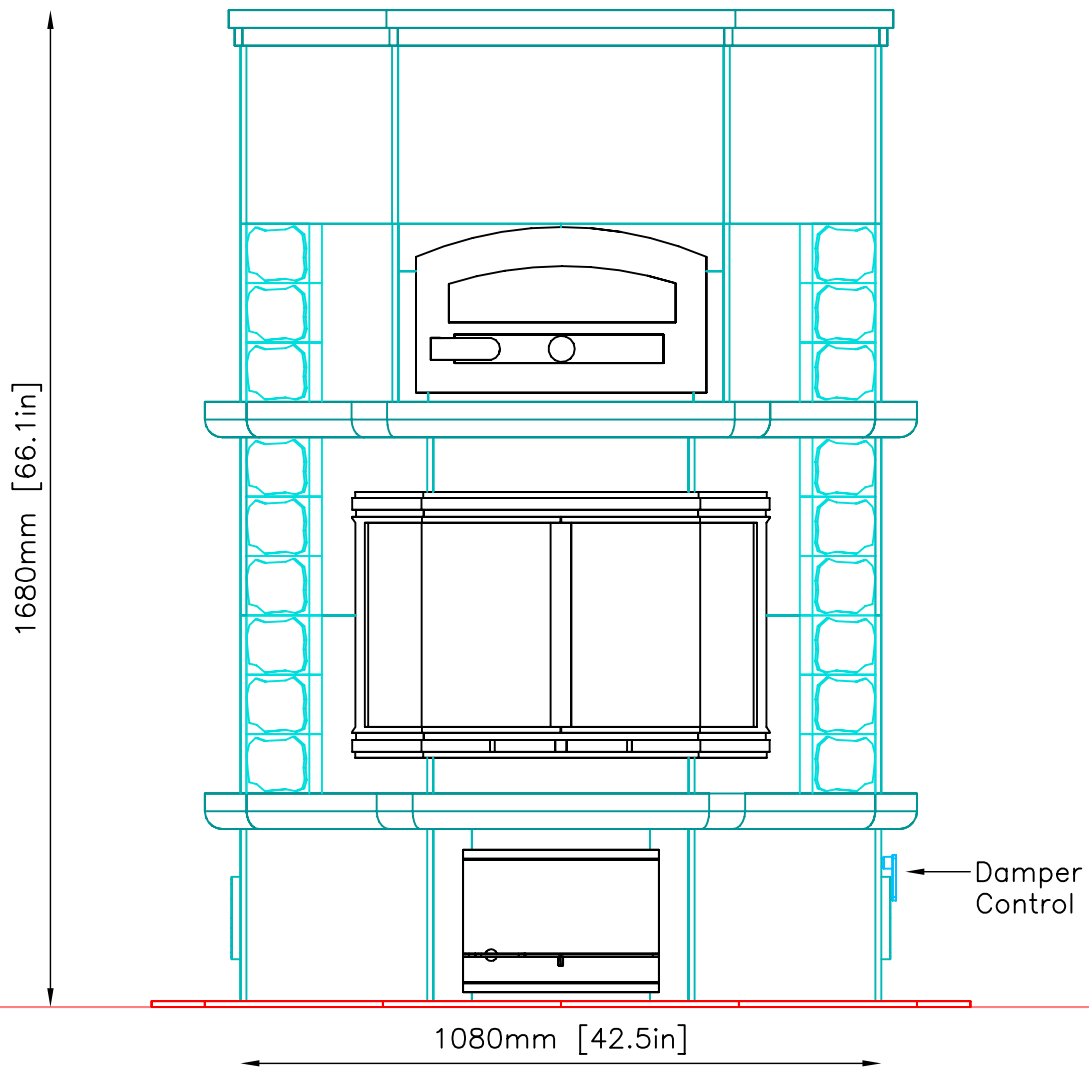

NOTE: Hearth Tiles CUT AND INSTALLED by others



MID-ATLANTIC MASONRY HEAT
1229 Harris Street Suite 1
Charlottesville, VA 22903
(434)979-9709 Fax 434-979-6416

PROJECT
CREATORE
MODEL
TLU2630/1

CONTRACT
5638
DRAWN BY
D.P.BYRAM

VIEW
FRONT
DATE
3/27/04

PAGE

2

SIDE VIEW

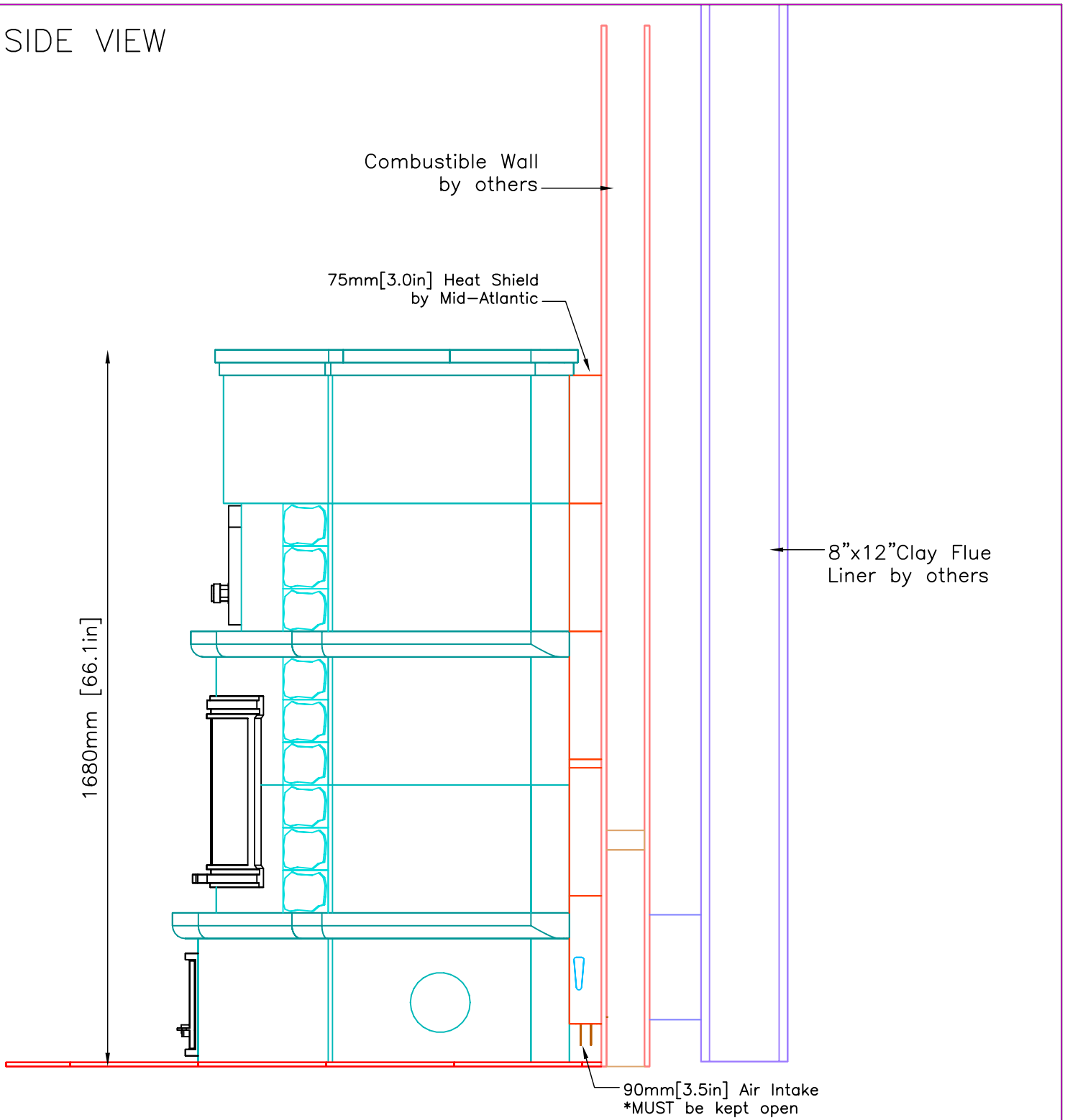

INFORMATION ONLY

NOTE: Hearth Tiles CUT AND INSTALLED by others



MID-ATLANTIC MASONRY HEAT
1229 Harris Street Suite 1
Charlottesville, VA 22903
(434)979-9709 Fax 434-979-6416

PROJECT CREATORE
MODEL TLU2630/1

CONTRACT 5638
DRAWN BY D.P.BYRAM

VIEW SIDE
DATE 3/27/04

PAGE 3

INFORMATION ONLY

PLAN VIEW

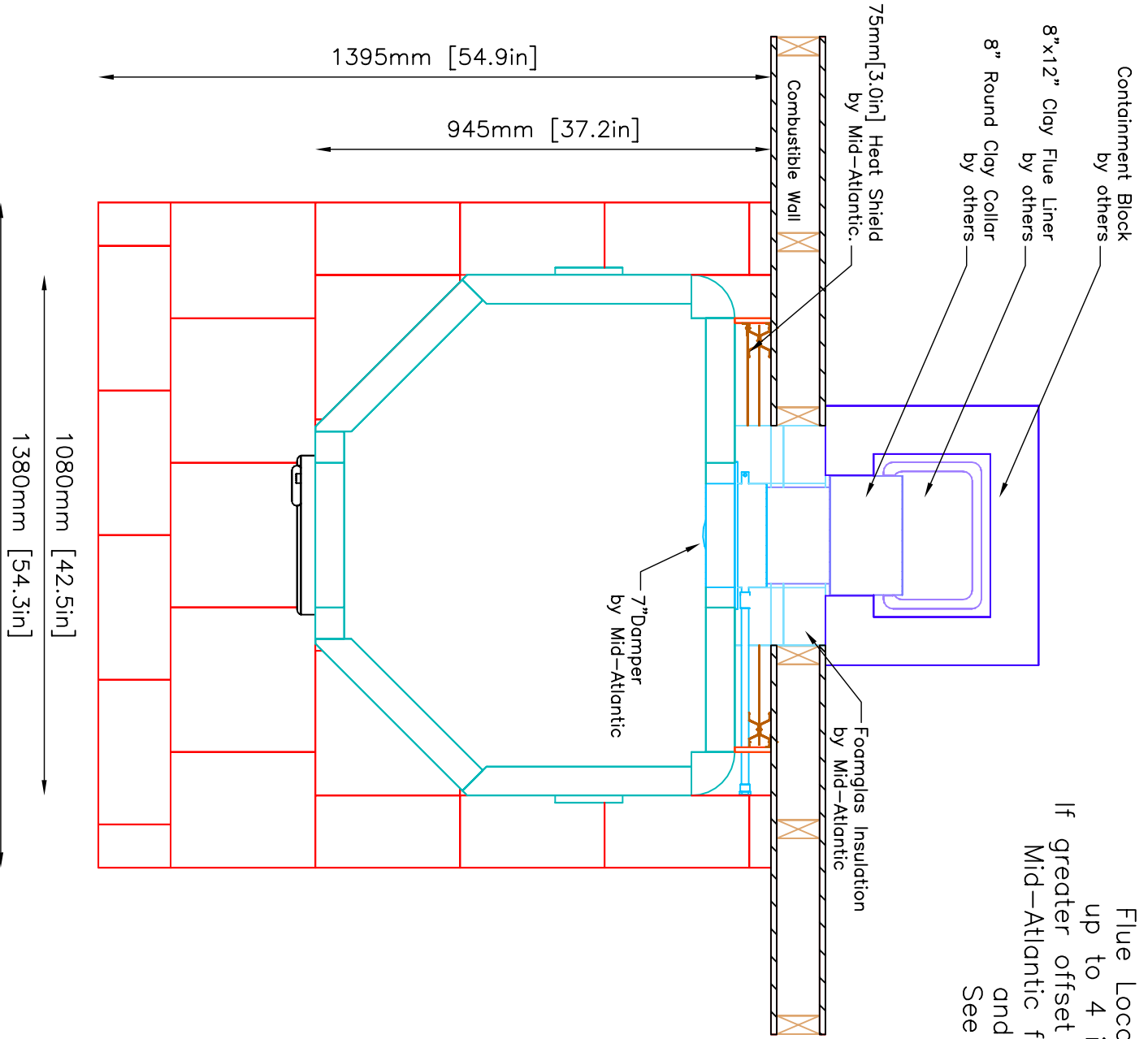

Flue Location may be offset up to 4 inches right or left. If greater offset is needed, contact Mid-Atlantic for revised drawings and installation pricing. See page 7 for Details

NOTE: Hearth Tiles CUT AND INSTALLED by others

	MID-ATLANTIC MASONRY HEAT 1229 Harris Street Suite 1 Charlottesville, VA 22903 (434)979-9709 Fax 434-979-6416	PROJECT	CREATORE	CONTRACT	5638	VIEW	PLAN	PAGE	4
		MODEL	TLU2630/1	DRAWN BY	D.P.BYRAM	DATE	3/27/04		

FOUNDATION SLAB

Minimum 4" Thick Poured Concrete With Rebar 6"O.C.
 Minimum Dimensions--2" from Base of Unit

INFORMATION ONLY

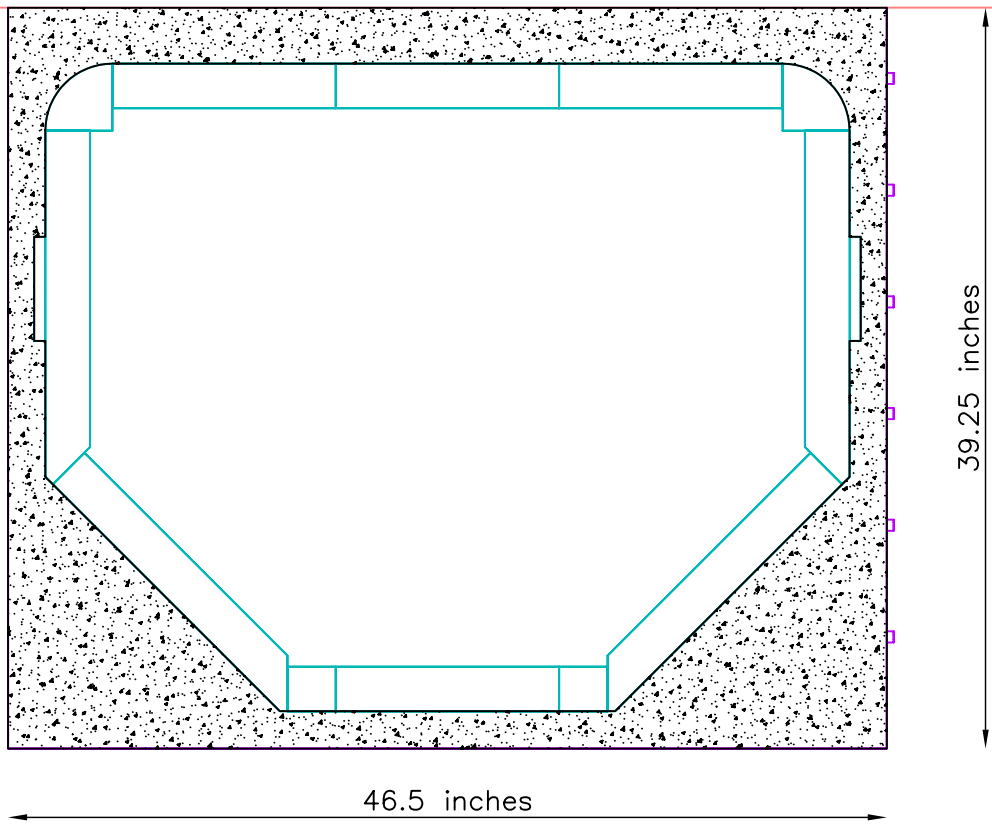

NOTE:
 TOP OF FOUNDATION SLAB TO BE LEVEL AND FLUSH WITH SUB-FLOOR
 Tolerances: +/- 1/8" No additional cost to level slab
 +/- 1/4" \$150.00-\$200.00 additional cost to level slab
 +/- 1/2" \$500.00 additional cost to level slab

UNIT WEIGHT: 5500lbs.
 Owner/Contractor is responsible for engineering Foundation Slab to support weight of fireplace.

TULIKIVI 	MID-ATLANTIC MASONRY HEAT 1229 Harris Street Suite 1 Charlottesville, VA 22903 (434)979-9709 Fax 434-979-6416	PROJECT	CREATORE	CONTRACT	5638	VIEW	SUPPORT	PAGE 5
		MODEL	TLU2630/1	DRAWN BY	D.P.BYRAM	DATE	3/27/04	

FOUNDATION SLAB:
 * MINIMUM 4" THICK
 WITH REBAR 6" O.C.
 * NON-COMBUSTIBLE
 CEMENT BOARD
 under foundation slab
 (NOT PLYWOOD)

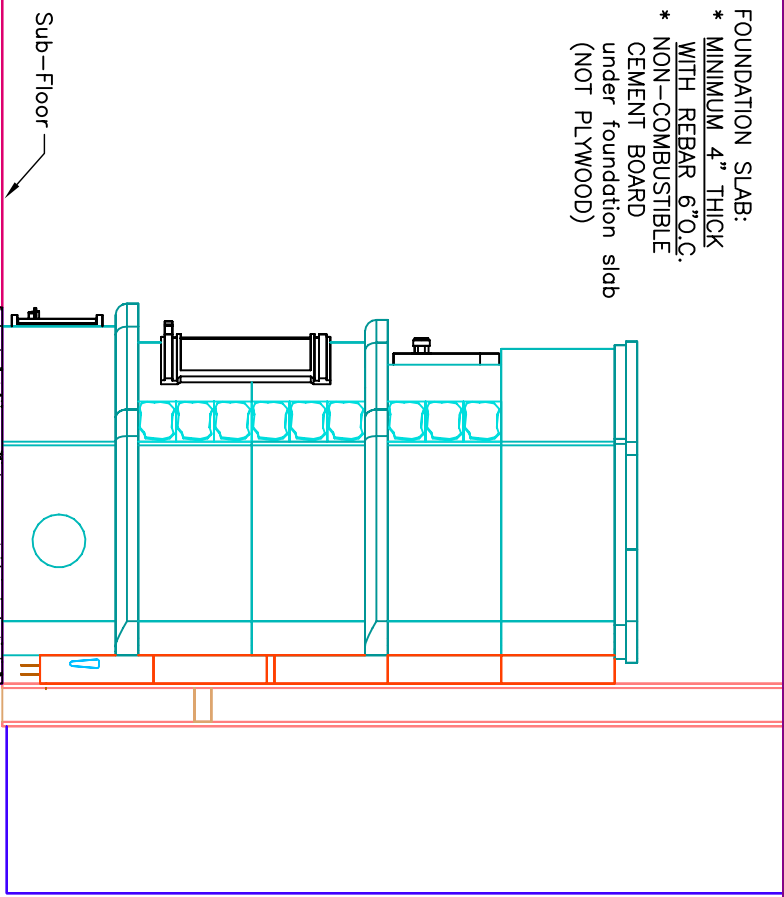

FOUNDATION SLAB:
 MINIMUM 4" THICK
 POURED CONCRETE
 WITH REBAR 6" O.C.

NON-COMBUSTIBLE
 CEMENT BOARD
 UNDER FOUNDATION
 SLAB (NOT PLYWOOD)

NOTE:
 TOP OF FOUNDATION SLAB TO BE LEVEL
 AND FLUSH WITH SUB-FLOOR
 Tolerances:
 +/- 1/8" No additional cost
 +/- 1/4" to level slab \$150.00-\$200.00 additional
 cost to level slab
 +/- 1/2" \$500.00 additional cost
 to level slab

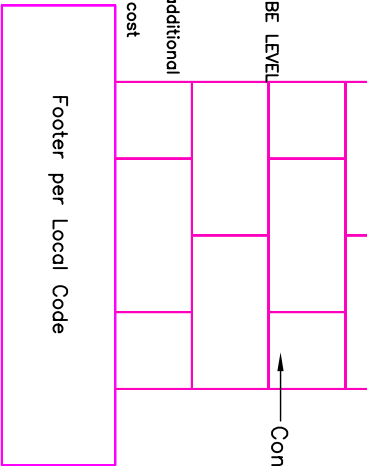

UNIT WEIGHT: 5500lbs.
 Owner/Contractor is responsible for engineering Foundation Slab to support weight of fireplace.

INFORMATION ONLY

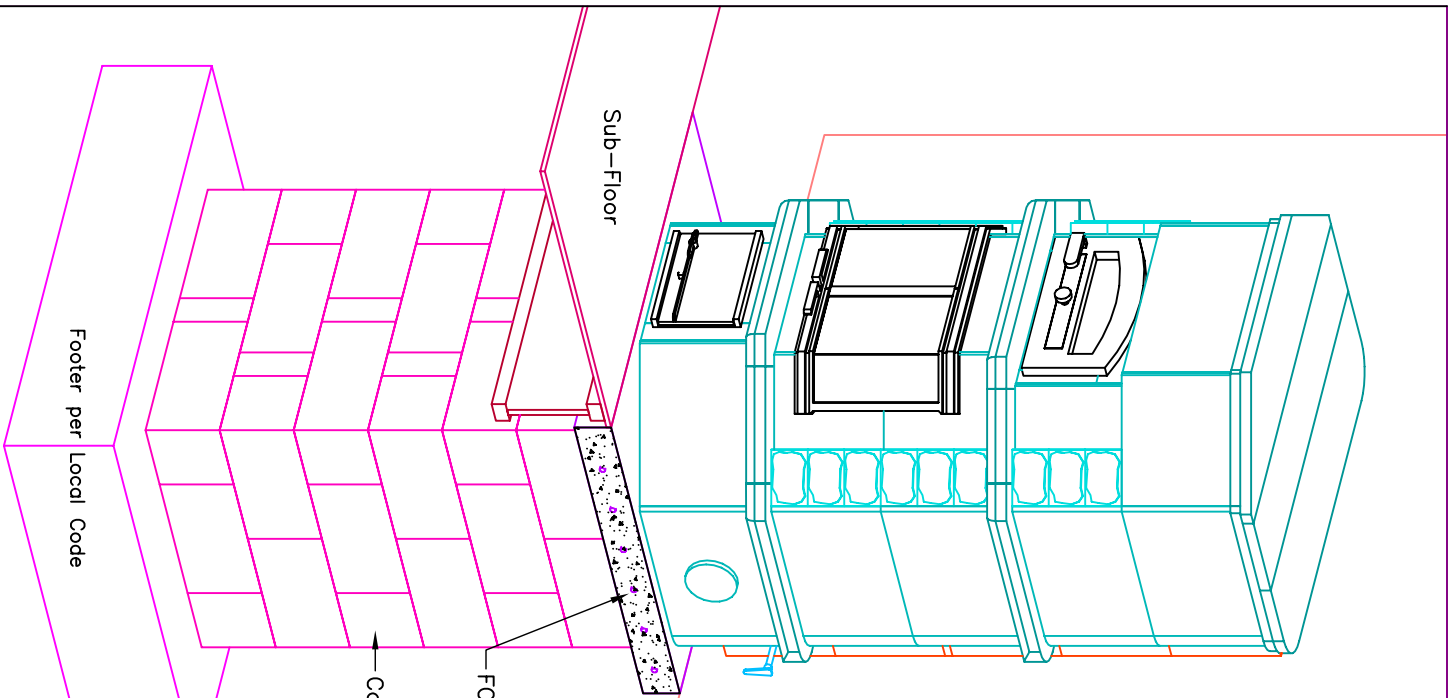

MID-ATLANTIC MASONRY HEAT
 McIntire Business Park
 Charlottesville, VA 22903
 (434)979-9709 Fax 434-979-6416

PROJECT CREATOR	CONTRACT 5638	VIEW Foundation Slab	PAGE 6
MODEL TLU2630/1	DRAWN BY D.P.BYRAM	DATE 3/27/04	

WALL ELEVATION

INFORMATION ONLY

Flue Location may be offset up to 4 inches right or left of center of fireplace.
 If greater offset is needed, contact Mid-Atlantic for revised drawings and installation pricing.
 SEE PAGE 4

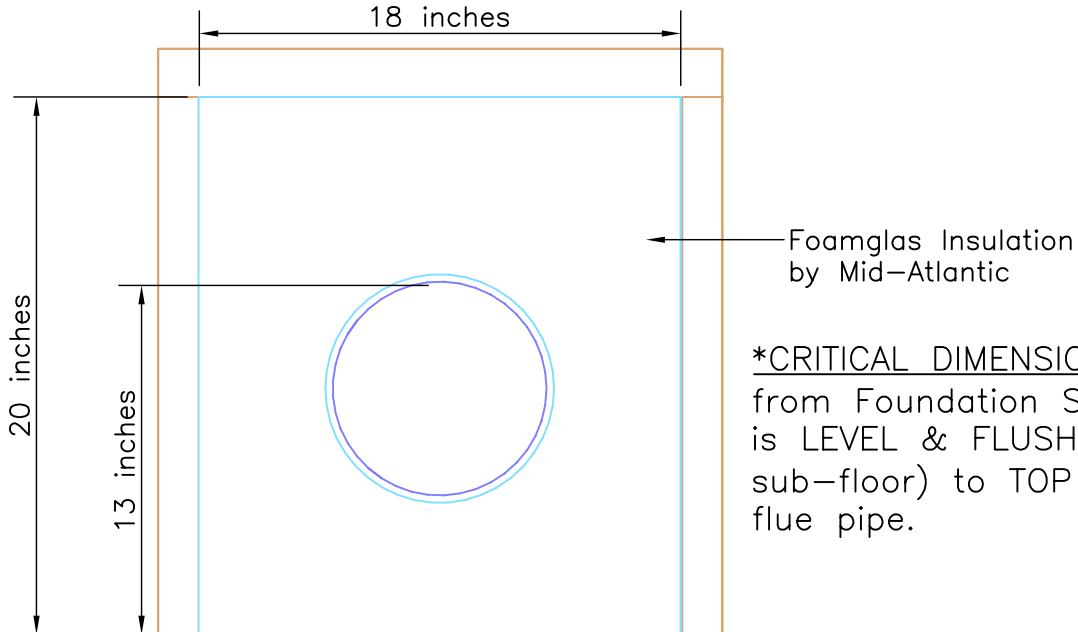

***CRITICAL DIMENSION:** 13" from Foundation Slab (which is LEVEL & FLUSH with sub-floor) to TOP INSIDE flue pipe.

FOUNDATION SLAB

Thickness of Finished Floor—Maximum $\frac{3}{4}$ ".
 If Finished Floor exceeds $\frac{3}{4}$ " Thickness Mid-Atlantic MUST be contacted for revised specifications.

Notes:

- Sheetrock behind Fireplace MUST be in place PRIOR to Installation.
- 18"X20" Opening MUST be in place PRIOR to Installation.
- UL Listed — Minimum Foamglas Insulation 4" on sides & 6" on top of Flue Pipe.

Chimney Placement

*CRITICAL DIMENSION: 13" from Foundation Slab (which is LEVEL & FLUSH with sub-floor) to TOP INSIDE flue pipe.

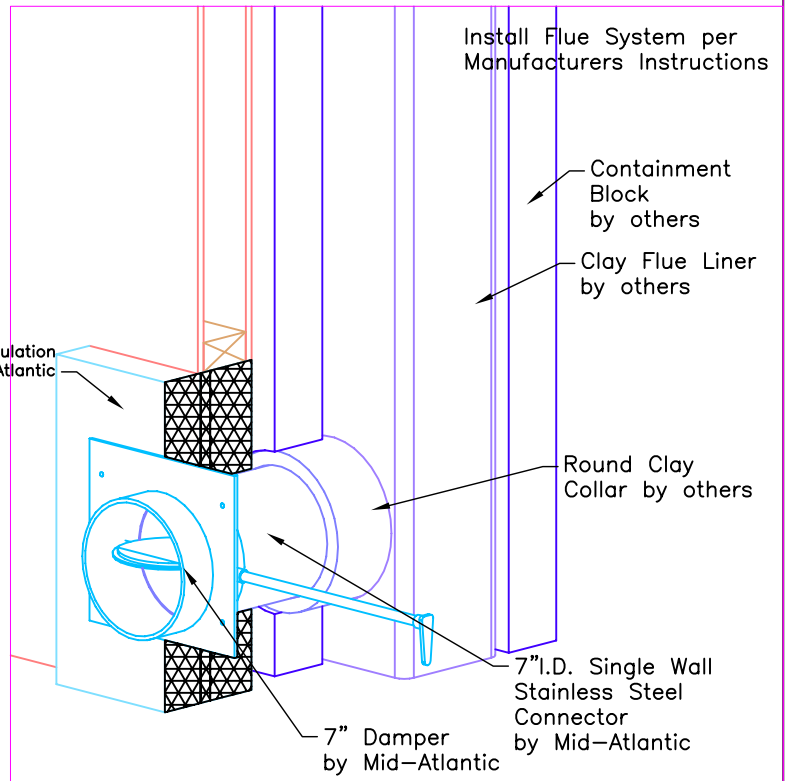

MID-ATLANTIC MASONRY HEAT
 1229 Harris Street Suite 1
 Charlottesville, VA 22903
 (434)979-9709 Fax 434-979-6416

PROJECT CREATURE
 MODEL TLU2630/1

CONTRACT 5638
 DRAWN BY D.P.BYRAM

VIEW Wall Elevation
 DATE 3/27/04

PAGE 7