

INFORMATION ONLY

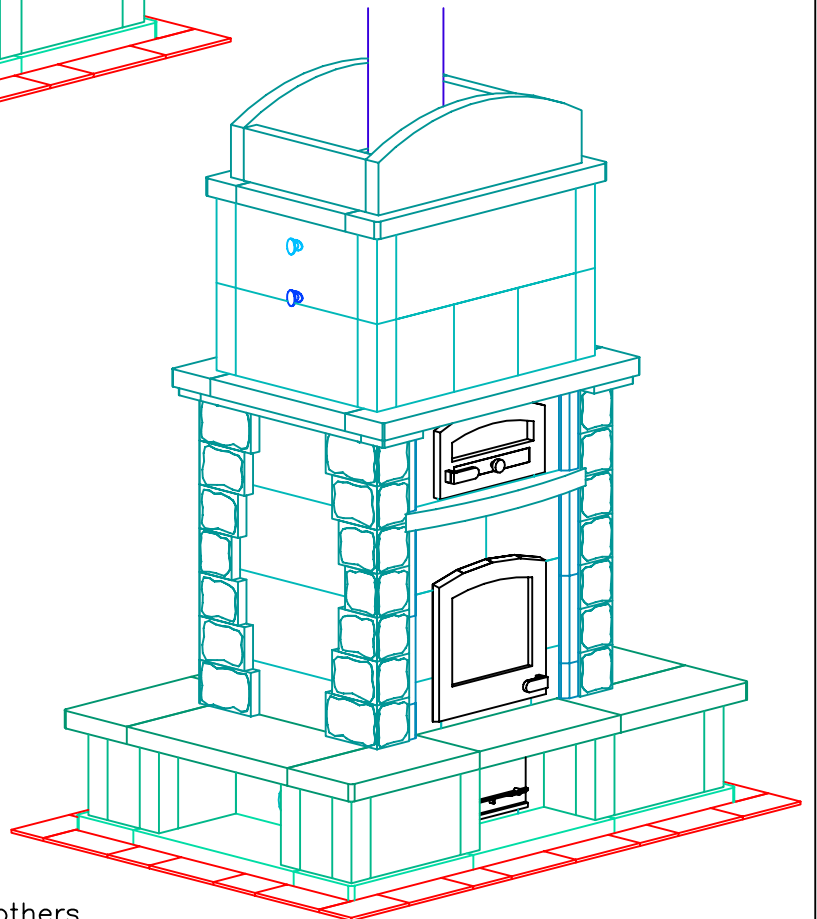

NOTE: Hearth Tiles CUT AND INSTALLED by others

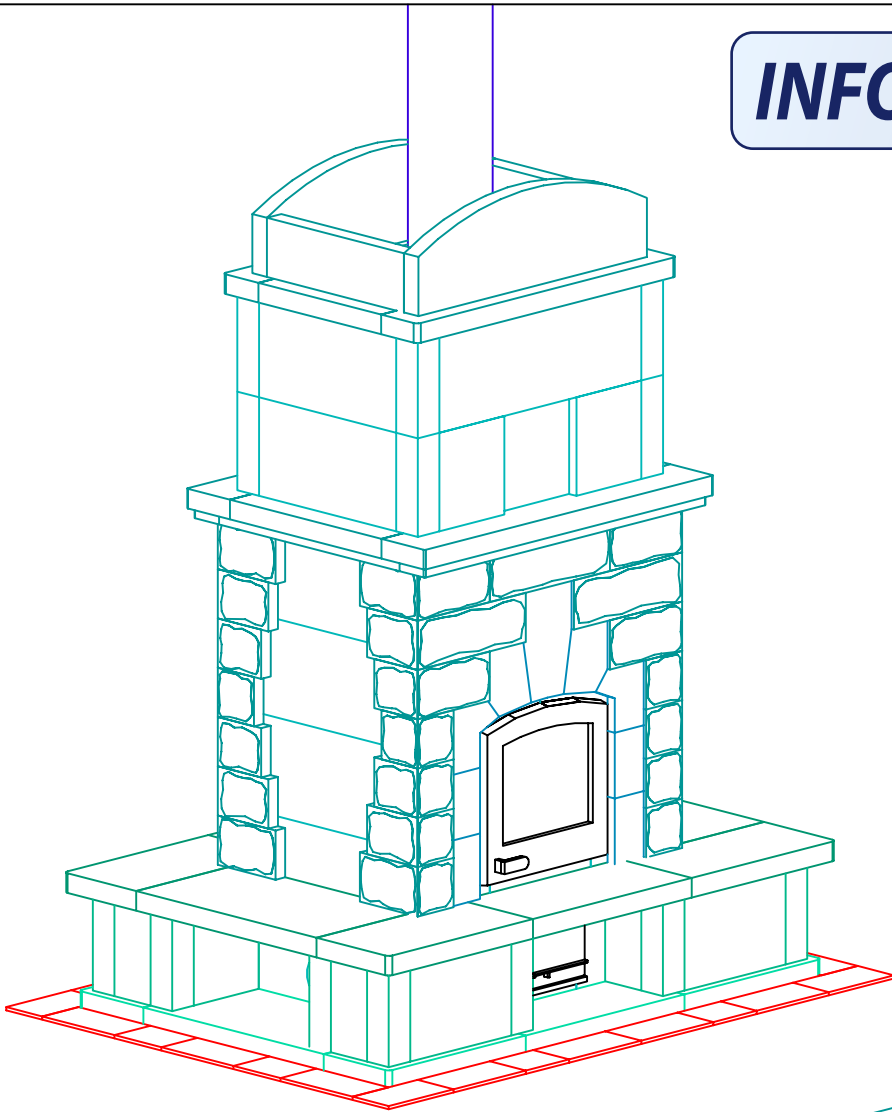

MID-ATLANTIC MASONRY HEAT
 1229 Harris Street Suite 1
 Charlottesville, VA 22903
 (434)979-9709 Fax 434-979-6416

PROJECT BOND
 MODEL TTU2700/5

CONTRACT 5655
 DRAWN BY D.P.BYRAM

VIEW PERSPECTIVE
 DATE 6/07/04

PAGE 1

FIREPLACE VIEW

INFORMATION ONLY

8" I.D./10" O.D. Double Wall
Stainless Steel Flue Pipe
by others

Soapstone Crown
Extension

Main Damper
Control

Bypass Damper
Control

Inset Niche

Soapstone Arch

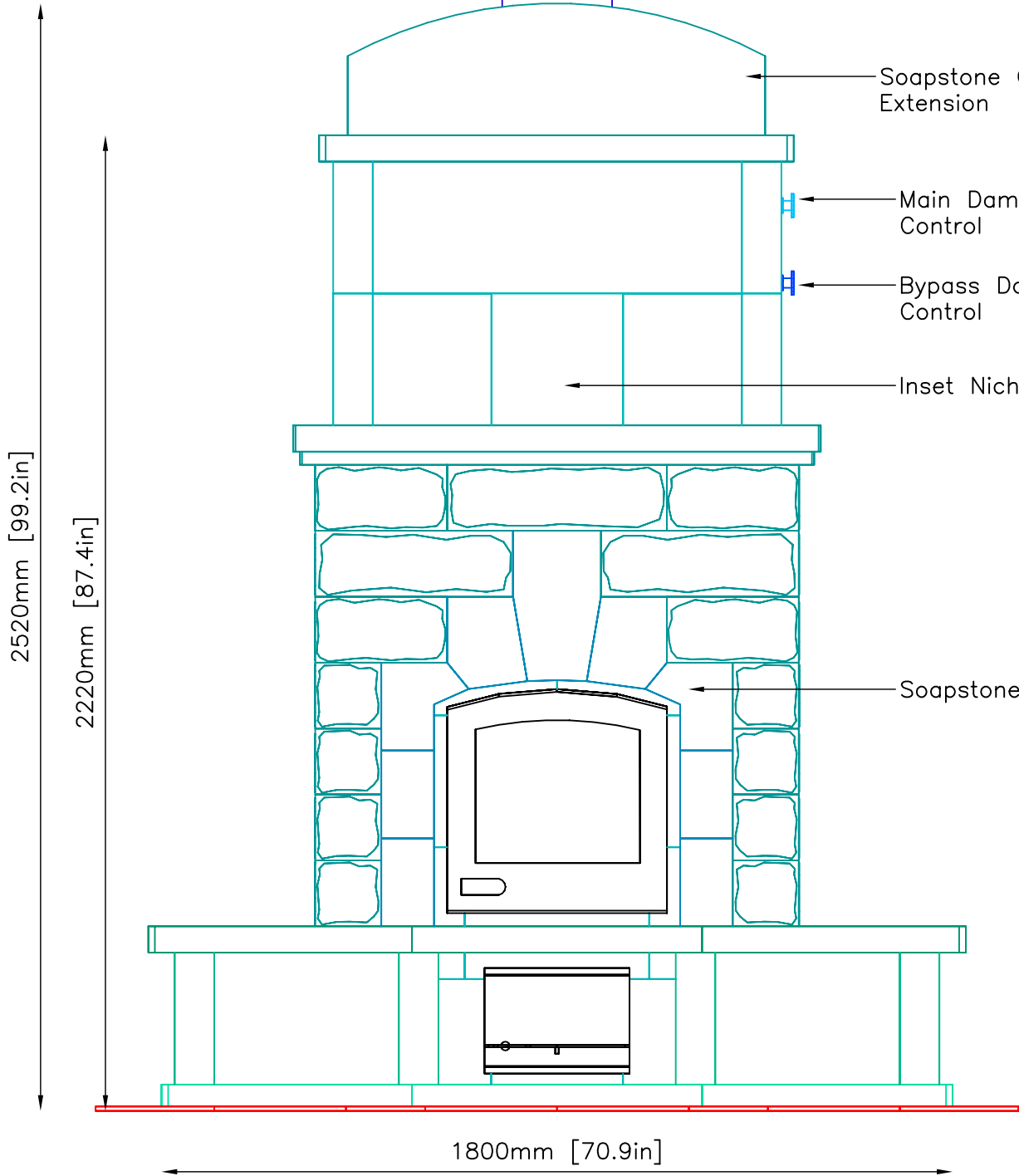

NOTE: Hearth Tiles CUT AND INSTALLED by others



MID-ATLANTIC MASONRY HEAT
1229 Harris Street Suite 1
Charlottesville, VA 22903
(434)979-9709 Fax 434-979-6416

PROJECT BOND
MODEL TTU2700/5

CONTRACT 5655
DRAWN BY D.P.BYRAM

VIEW FIREPLACE
DATE 6/07/04

PAGE 2

BAKEOVEN VIEW

INFORMATION ONLY

← 8”I.D./10”O.D.Double Wall
Stainless Steel Flue Pipe
by others

Soapstone Crown
Extension →

Main Damper
Control →

Bypass Damper
Control →

Soapstone Trim →

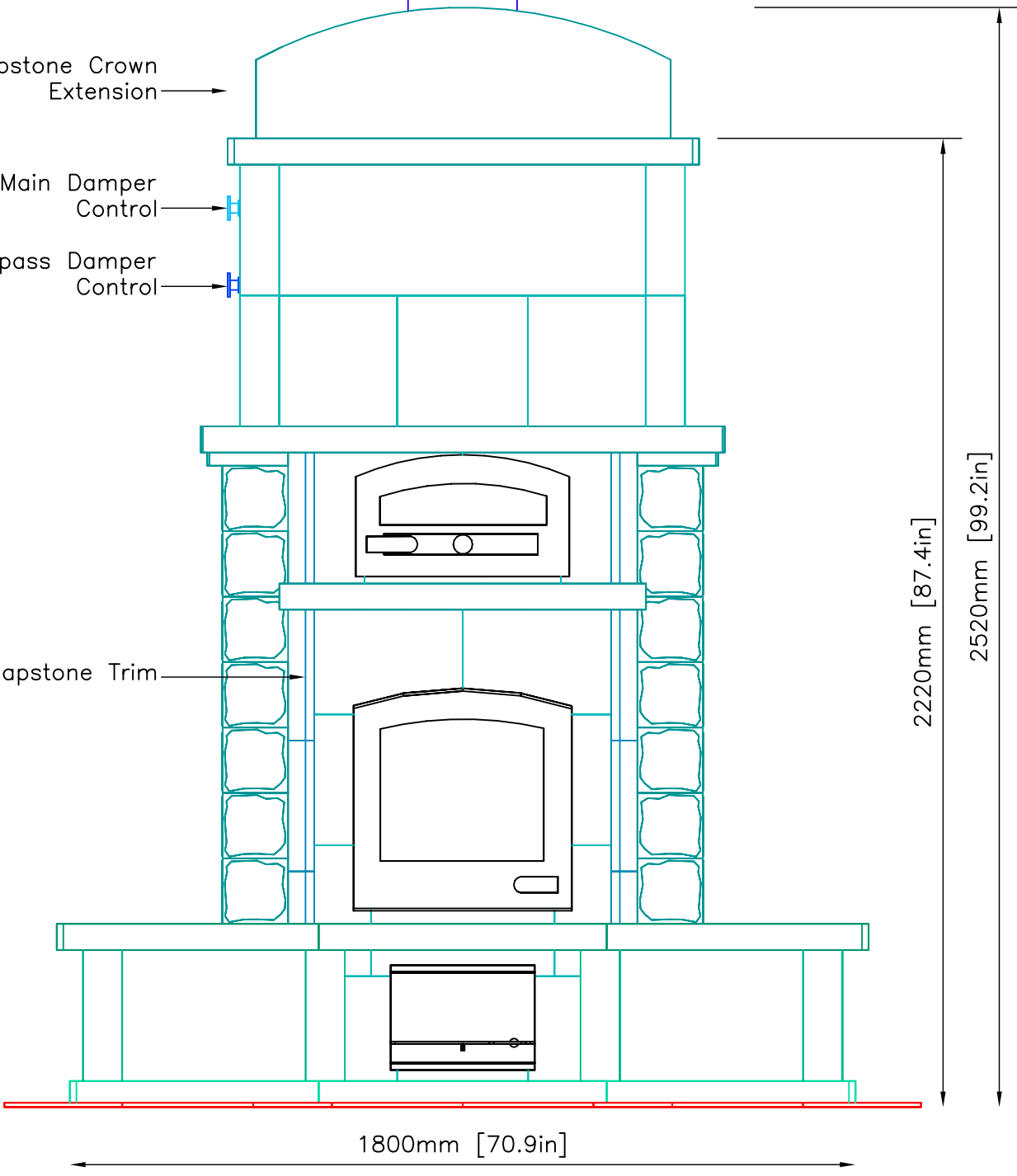

NOTE: Hearth Tiles CUT AND INSTALLED by others



MID-ATLANTIC MASONRY HEAT
1229 Harris Street Suite 1
Charlottesville, VA 22903
(434)979-9709 Fax 434-979-6416

PROJECT BOND
MODEL TTU2700/5

CONTRACT 5655
DRAWN BY D.P.BYRAM

VIEW BAKEOVEN
DATE 6/07/04

PAGE 3

SIDE VIEW

2520mm [99.2in]

2400mm [94.5in]

2220mm [87.4in]

1290mm [50.8in]

8"i.D./10"O.D. Double Wall
Stainless Steel Flue Pipe
by others

Soapstone Crown
Extension

Main Damper
Control

Bypass Damper
Control

INFORMATION ONLY

NOTE: Hearth Tiles CUT AND INSTALLED by others



MID-ATLANTIC MASONRY HEAT
1229 Harris Street Suite 1
Charlottesville, VA 22903
(434)979-9709 Fax 434-979-6416

PROJECT BOND
MODEL TTU2700/5

CONTRACT 5655
DRAWN BY D.P.BYRAM

VIEW SIDE
DATE 6/07/04

PAGE

4

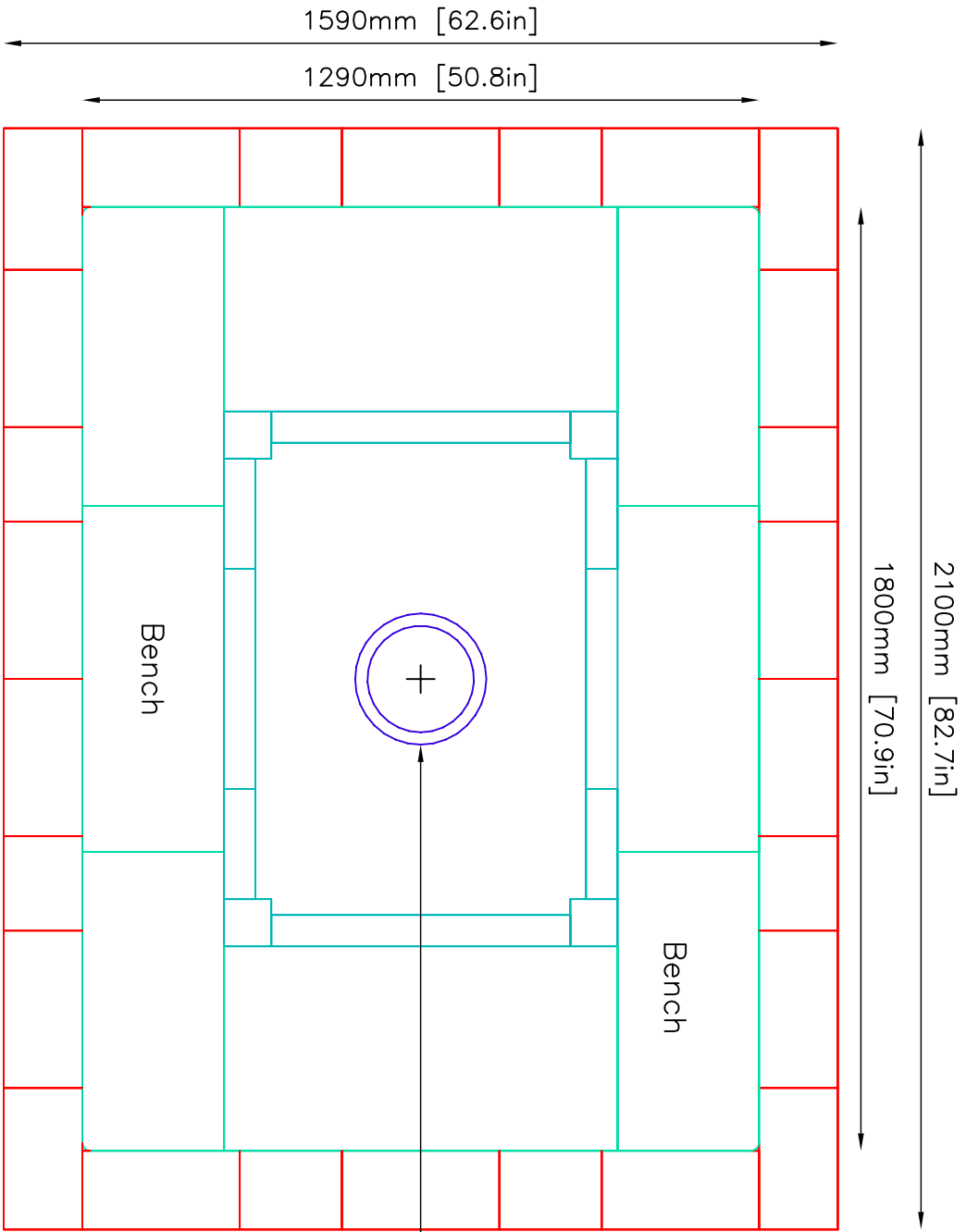

8" I.D./10" O.D. Double Wall
Stainless Steel Flue Pipe
by others
SEE PAGE 5 FOR
FLUE LOCATION

NOTE: Hearth Tiles CUT AND INSTALLED by others

INFORMATION ONLY

TULIKIVI 	MID-ATLANTIC MASONRY HEAT 1229 Harris Street Suite 1 Charlottesville, VA 22903 (434)979-9709 Fax 434-979-6416		PROJECT BOND	CONTRACT 5655	VIEW PLAN	PAGE 5
	MODEL TTU2700/5	DRAWN BY D.P.BYRAM		DATE 6/07/04		

FOUNDATION SLAB

Minimum 4" Thick Poured Concrete With Rebar 6"O.C.
 Minimum Dimensions--2" from Base of Unit

INFORMATION ONLY

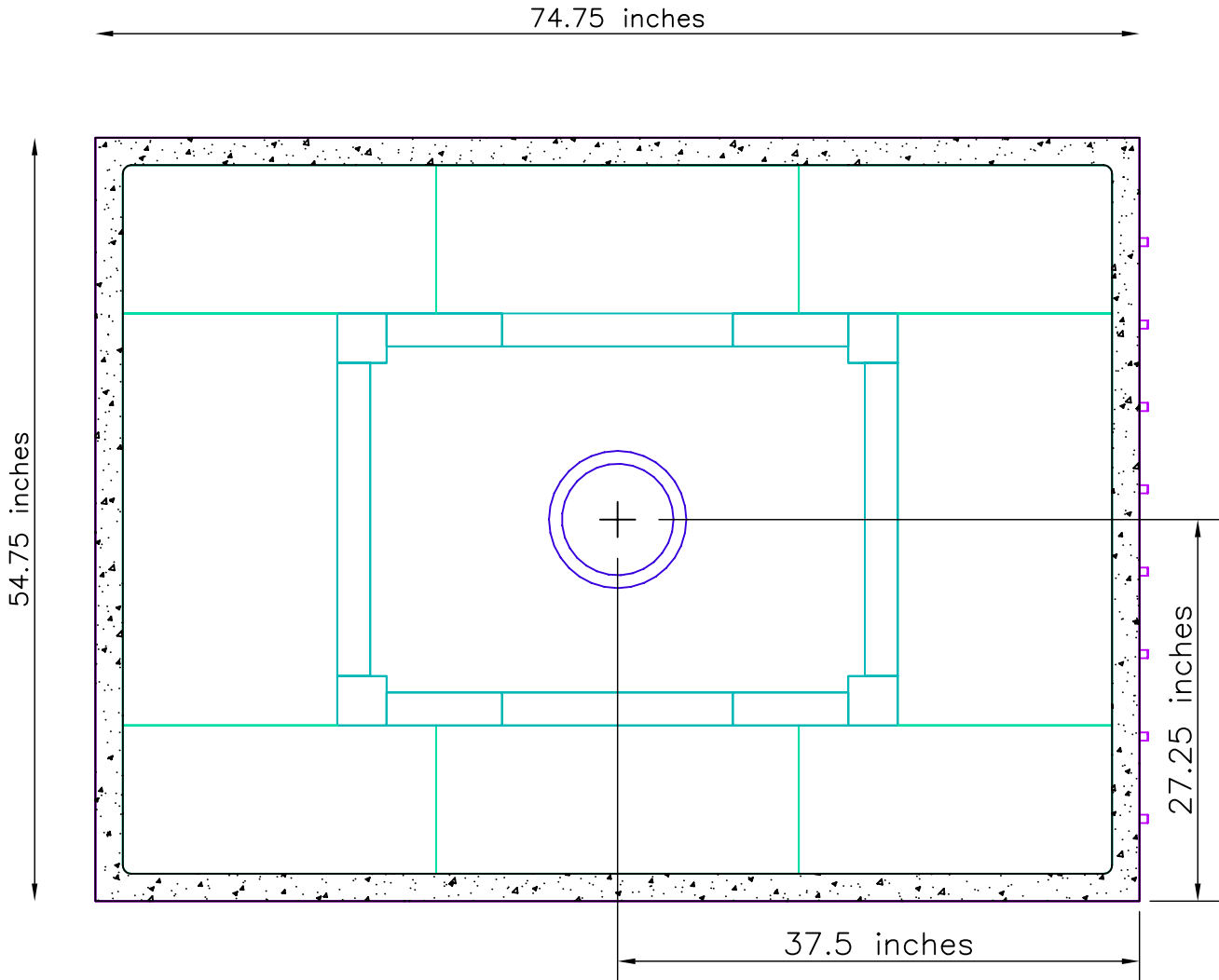

NOTE:
 TOP OF FOUNDATION SLAB TO BE LEVEL AND FLUSH WITH SUB-FLOOR
 Tolerances: +/- 1/8" No additional cost to level slab
 +/- 1/4" \$150.00-\$200.00 additional cost to level slab
 +/- 1/2" \$500.00 additional cost to level slab

UNIT WEIGHT: 10,500lbs.

Owner/Contractor is responsible for engineering Foundation Slab to support weight of fireplace.



MID-ATLANTIC MASONRY HEAT
 1229 Harris Street Suite 1
 Charlottesville, VA 22903
 (434)979-9709 Fax 434-979-6416

PROJECT BOND
 MODEL TTU2700/5

CONTRACT 5655
 DRAWN BY D.P.BYRAM

VIEW SUPPORT
 DATE 6/07/04

PAGE 6

FOUNDATION SLAB:
 * MINIMUM 4" THICK
 WITH REBAR 6" O.C.
 * NON-COMBUSTIBLE
 CEMENT BOARD
 under foundation slab
 (NOT PLYWOOD)

INFORMATION ONLY

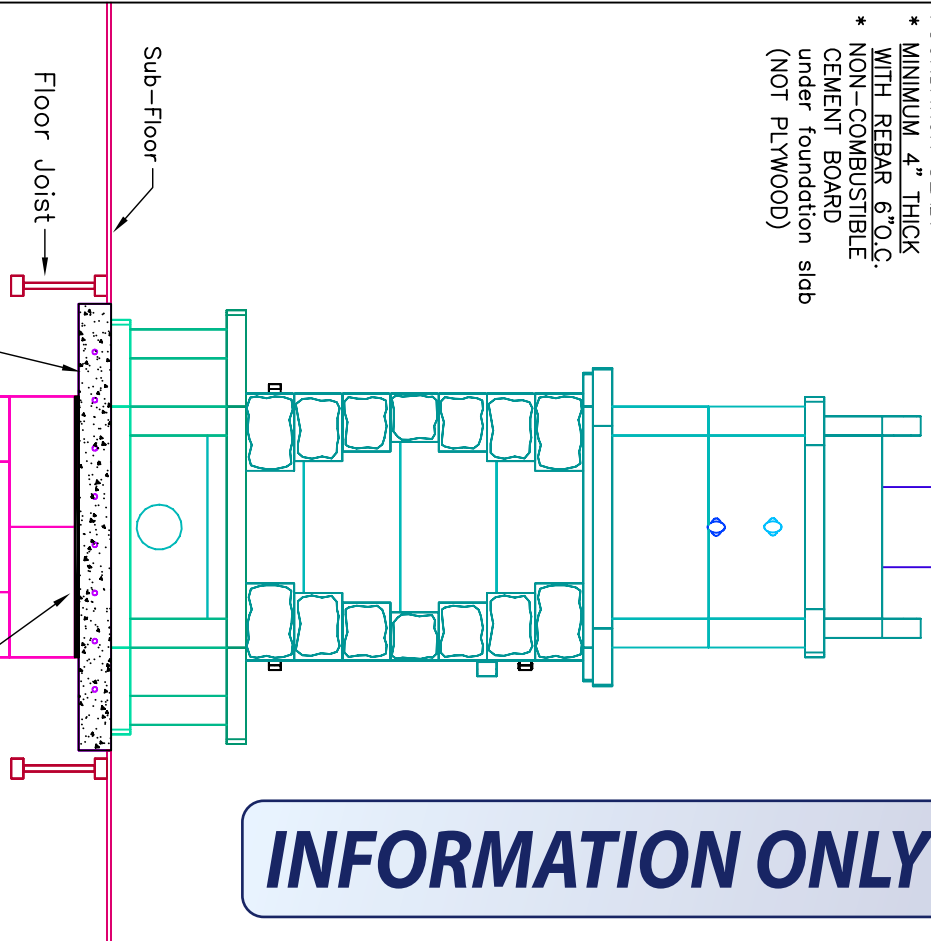

FOUNDATION SLAB:
 MINIMUM 4" THICK
 POURED CONCRETE
 WITH REBAR 6" O.C.

NOTE:
 TOP OF FOUNDATION SLAB TO BE LEVEL
 AND FLUSH WITH SUB-FLOOR
 Tolerances:
 +/- 1/8" No additional cost
 +/- 1/4" \$150.00-\$200.00 additional
 +/- 1/2" \$500.00 additional cost
 to level slab

Footer per Local Code

NON-COMBUSTIBLE
 CEMENT BOARD
 UNDER FOUNDATION
 SLAB (NOT PLYWOOD)

Concrete Block

UNIT WEIGHT: 10,500lbs.
 Owner/Contractor is responsible for engineering Foundation Slab to support weight of fireplace.

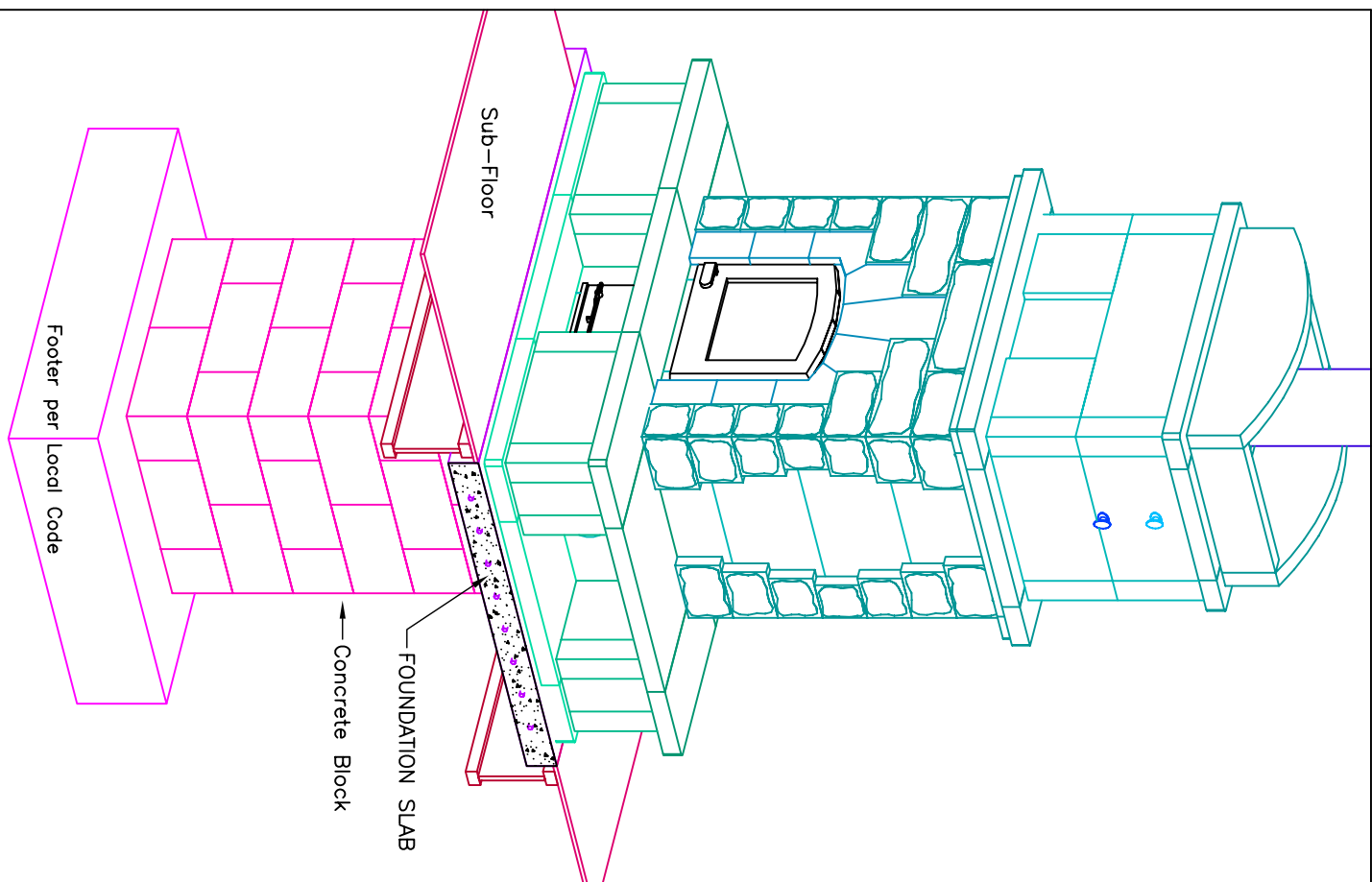

FOUNDATION SLAB

Concrete Block

Footer per Local Code