

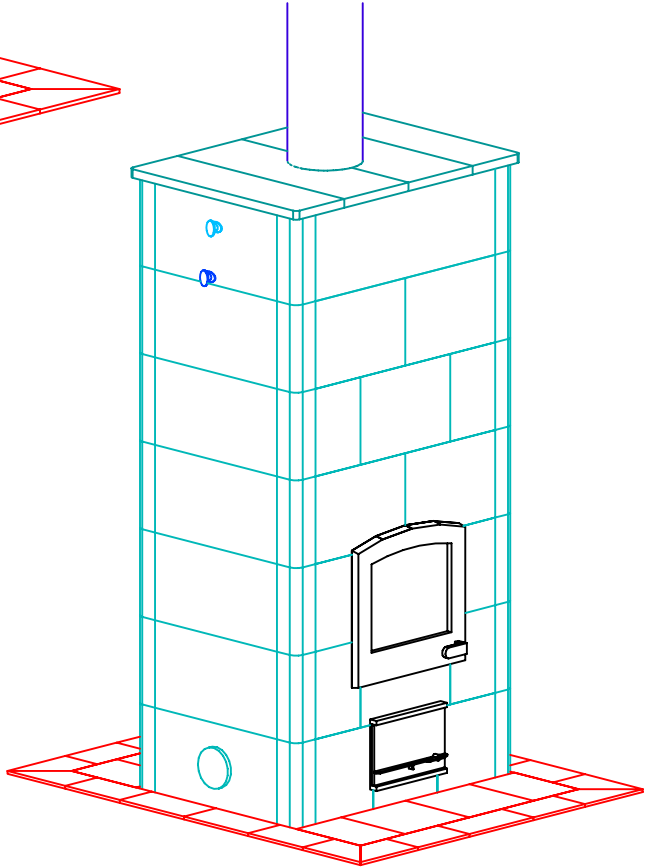

INFORMATION ONLY

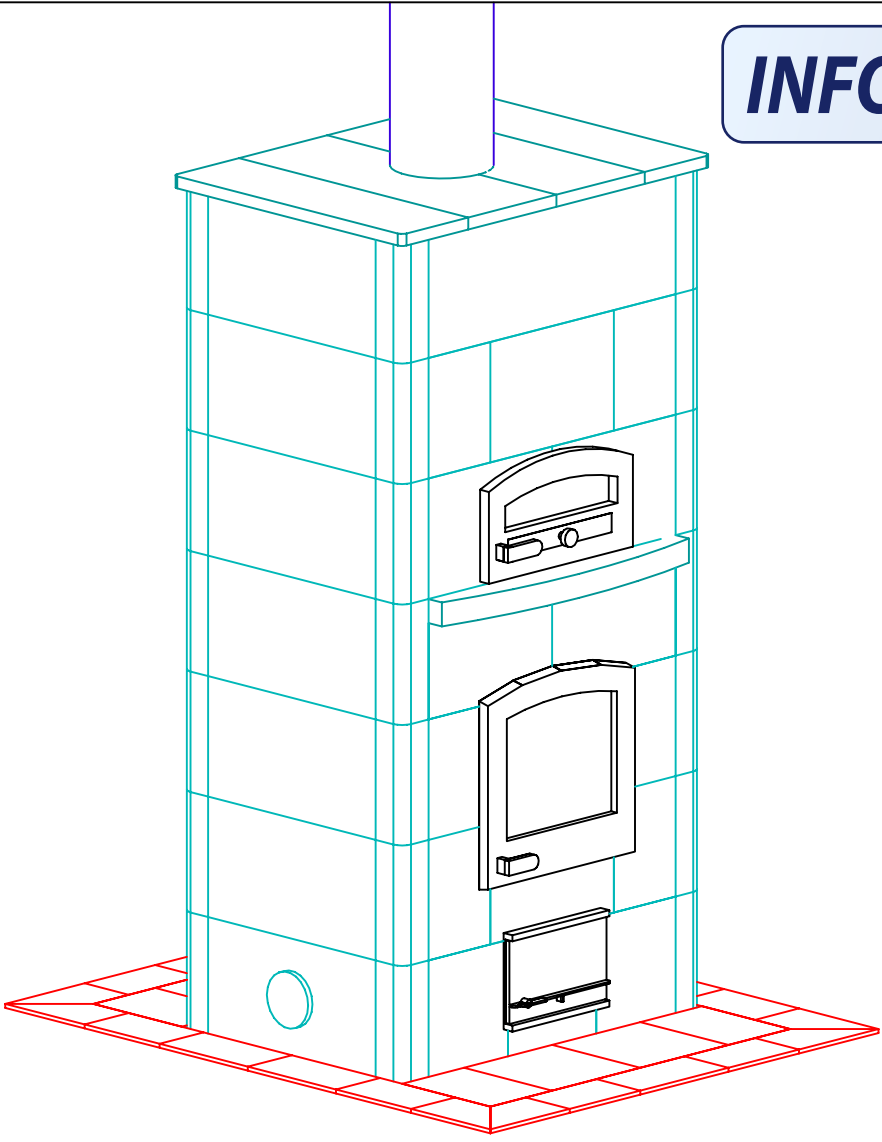

NOTE: Hearth Tiles CUT AND INSTALLED by others

TULIKIVI 	MID-ATLANTIC MASONRY HEAT 1229 Harris Street Suite 1 Charlottesville, VA 22903 (434)979-9709 Fax 434-979-6416	PROJECT	CASALE	CONTRACT	5644	VIEW	PERSPECTIVE	PAGE 1
		MODEL	TTU2700/5	DRAWN BY	D.P.BYRAM	DATE	4/23/04	

KITCHEN VIEW

INFORMATION ONLY

← 8" I.D./10" O.D. Double Wall
Stainless Steel Flue Pipe
by others

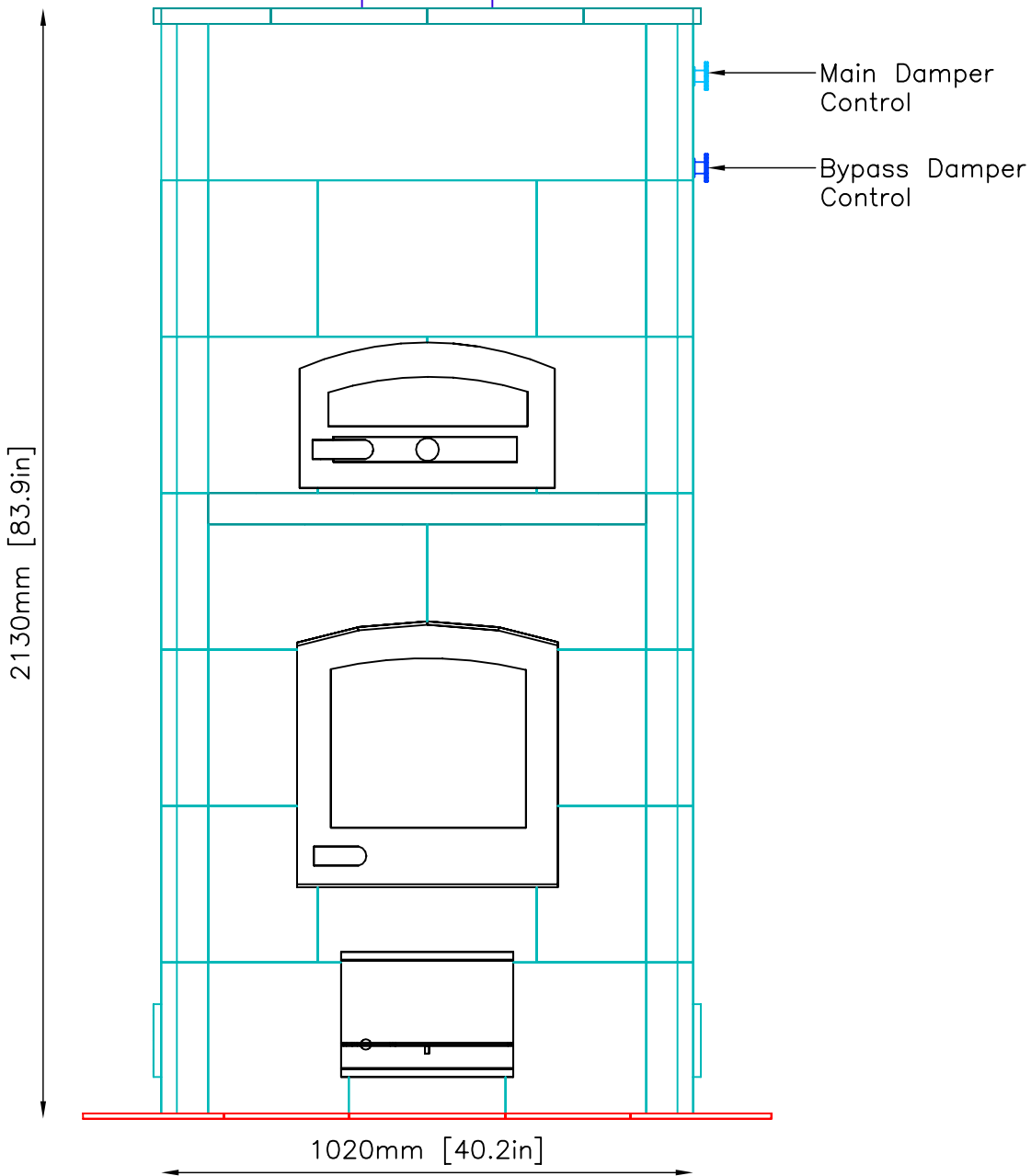

NOTE: Hearth Tiles CUT AND INSTALLED by others



MID-ATLANTIC MASONRY HEAT
1229 Harris Street Suite 1
Charlottesville, VA 22903
(434)979-9709 Fax 434-979-6416

PROJECT CASALE
MODEL TTU2700/5

CONTRACT 5644
DRAWN BY D.P.BYRAM

VIEW BAKEOVEN
DATE 4/23/04

PAGE

2

LIVINGROOM VIEW

INFORMATION ONLY

8" I.D./10" O.D. Double Wall
Stainless Steel Flue Pipe
by others

Main Damper
Control

Bypass Damper
Control

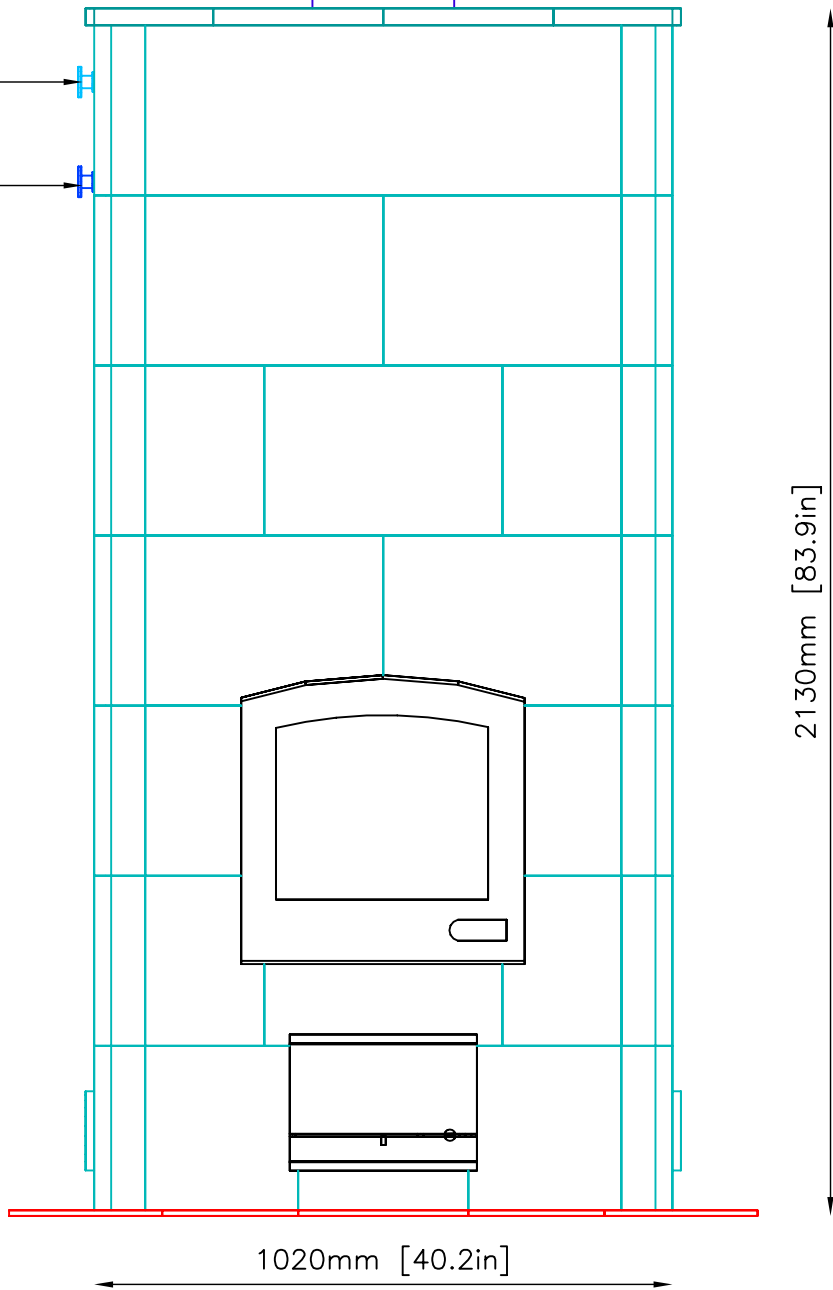

NOTE: Hearth Tiles CUT AND INSTALLED by others



MID-ATLANTIC MASONRY HEAT
1229 Harris Street Suite 1
Charlottesville, VA 22903
(434)979-9709 Fax 434-979-6416

PROJECT CASALE
MODEL TTU2700/5

CONTRACT 5644
DRAWN BY D.P.BYRAM

VIEW FIREPLACE
DATE 4/23/04

PAGE 3

SIDE VIEW

INFORMATION ONLY

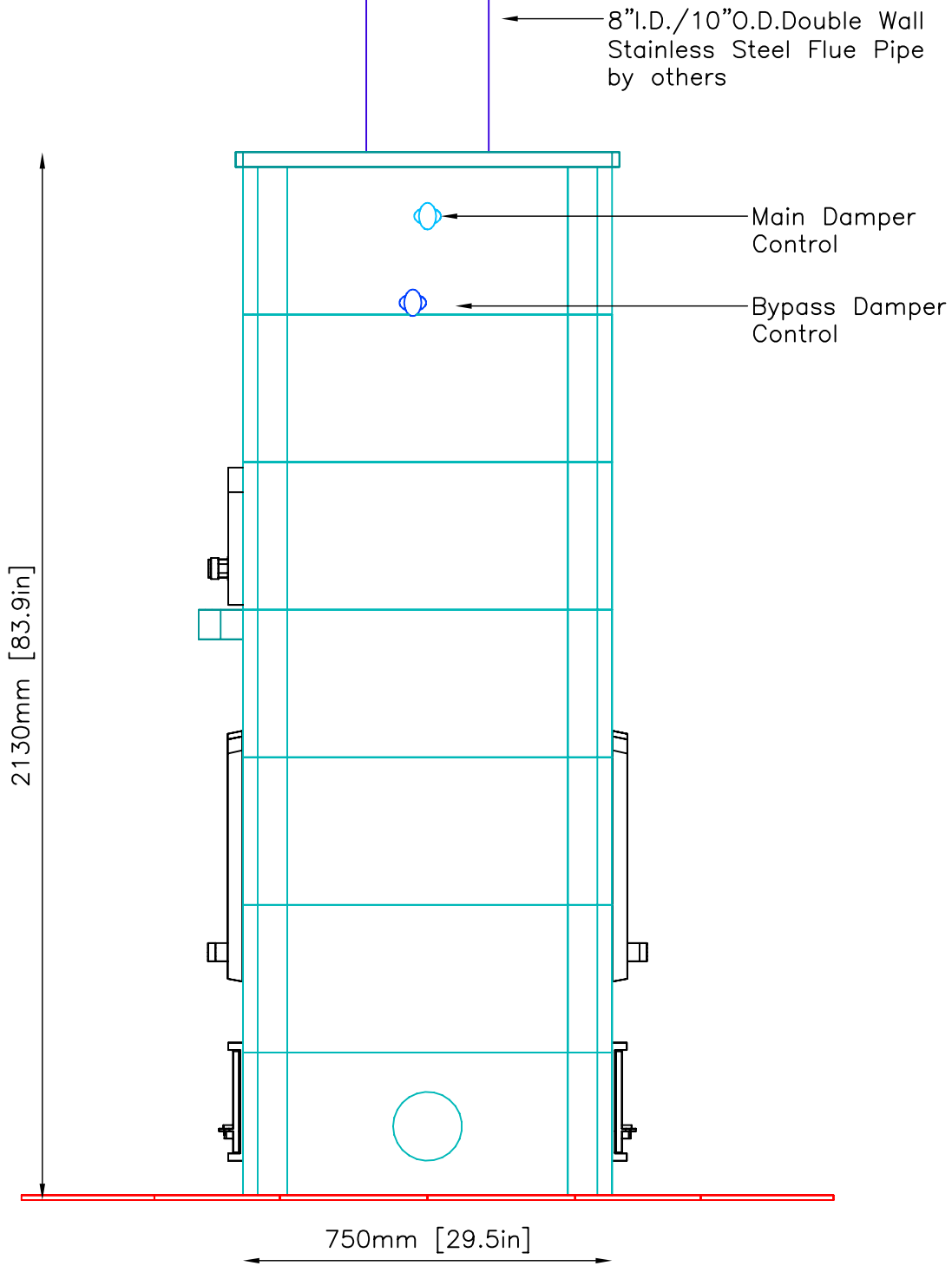

NOTE: Hearth Tiles CUT AND INSTALLED by others



MID-ATLANTIC MASONRY HEAT
1229 Harris Street Suite 1
Charlottesville, VA 22903
(434)979-9709 Fax 434-979-6416

PROJECT CASALE
MODEL TTU2700/5

CONTRACT 5644
DRAWN BY D.P.BYRAM

VIEW SIDE
DATE 4/23/04

PAGE

4

PLAN VIEW

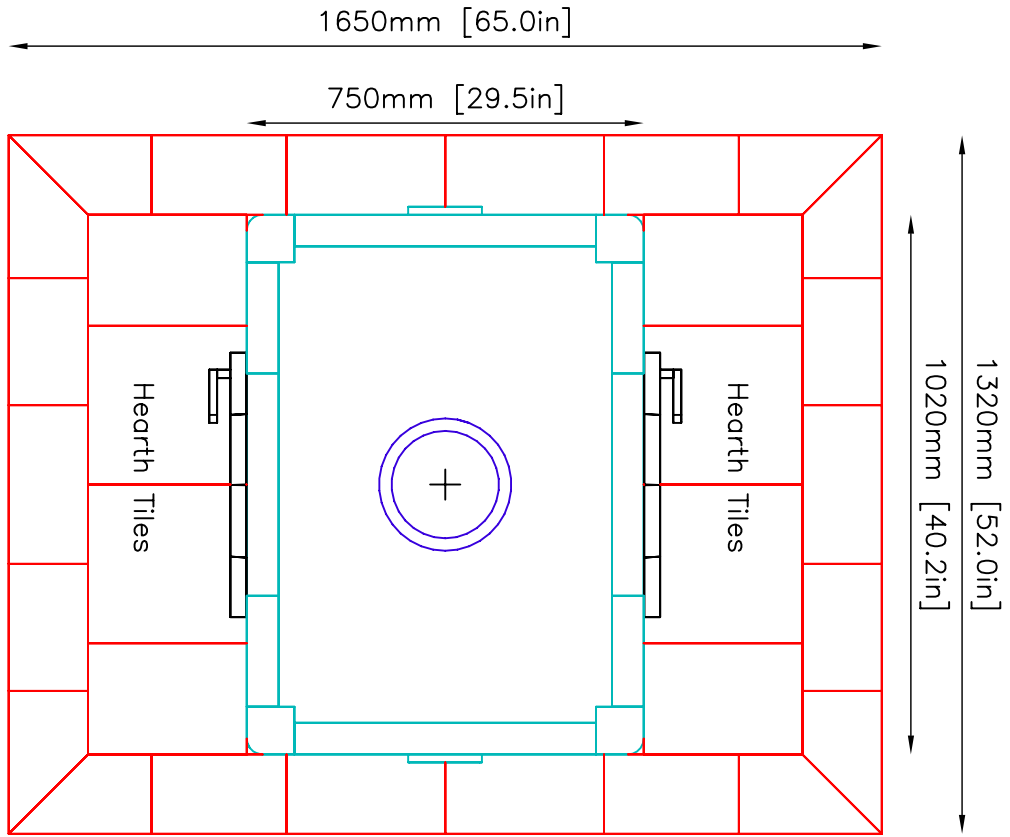

NOTE: Hearth Tiles CUT AND INSTALLED by others

FLUE LOCATION

INFORMATION ONLY

