

Revision: 1	Date 4/12/02	By: DP
Revision: 2	Date 7/24/02	By: DP

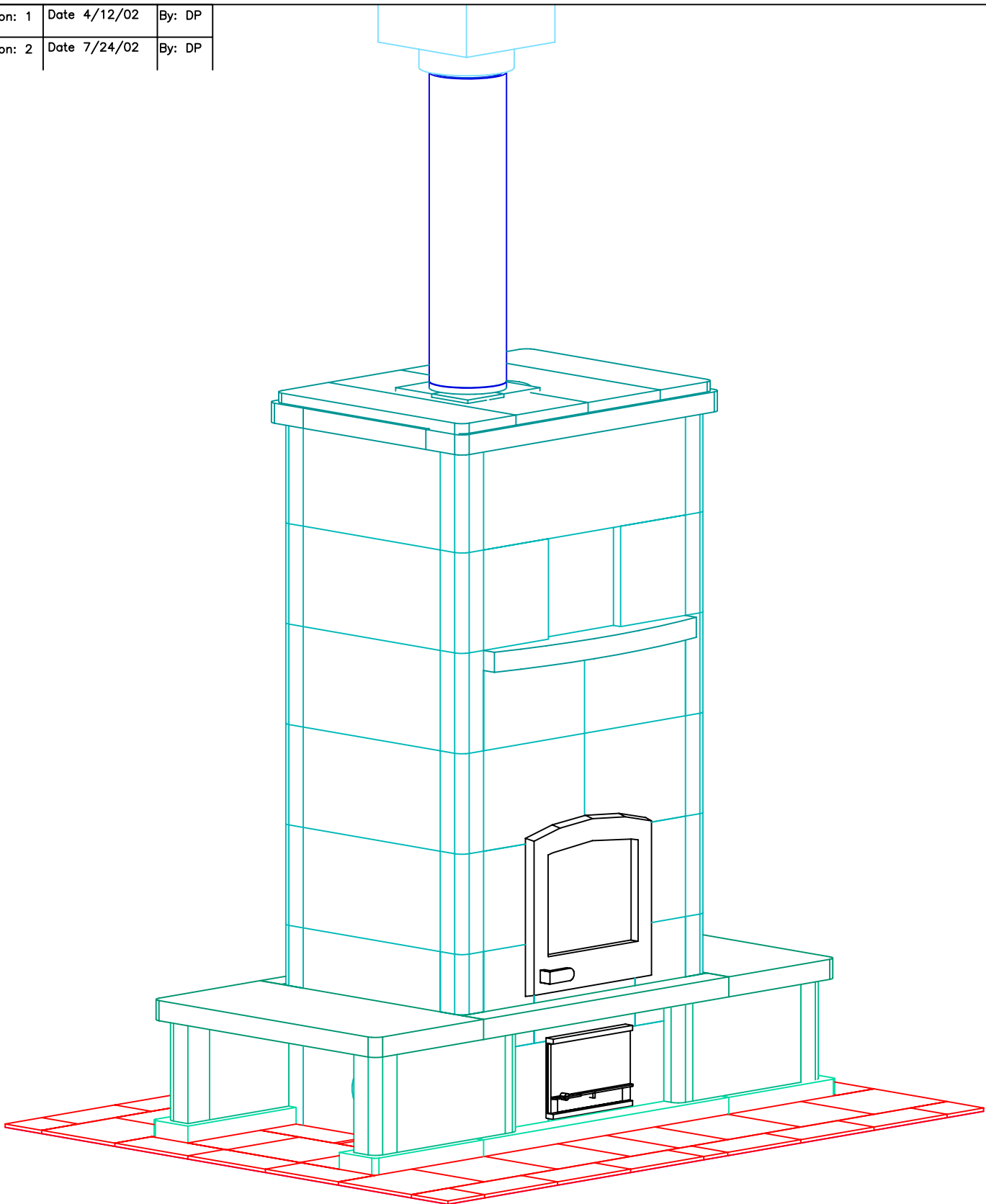

INFORMATION ONLY

NOTE: HEARTH TILES INSTALLED BY OTHERS



MID-ATLANTIC MASONRY HEAT
 McIntire Business Park
 Charlottesville, VA 22903
 (434)979-9707 Fax 434-979-6416

PROJECT FROSCHER
 MODEL TTU2700/1

CONTRACT 5181
 DRAWN BY D.POWLEY

VIEW ISOMETRIC
 DATE 1/23/02

PAGE 2

Revision: 1	Date 4/12/02	By: DP
Revision: 2	Date 7/24/02	By: DP
Revision: 3	Date 3/05/04	By: DPB

INFORMATION ONLY

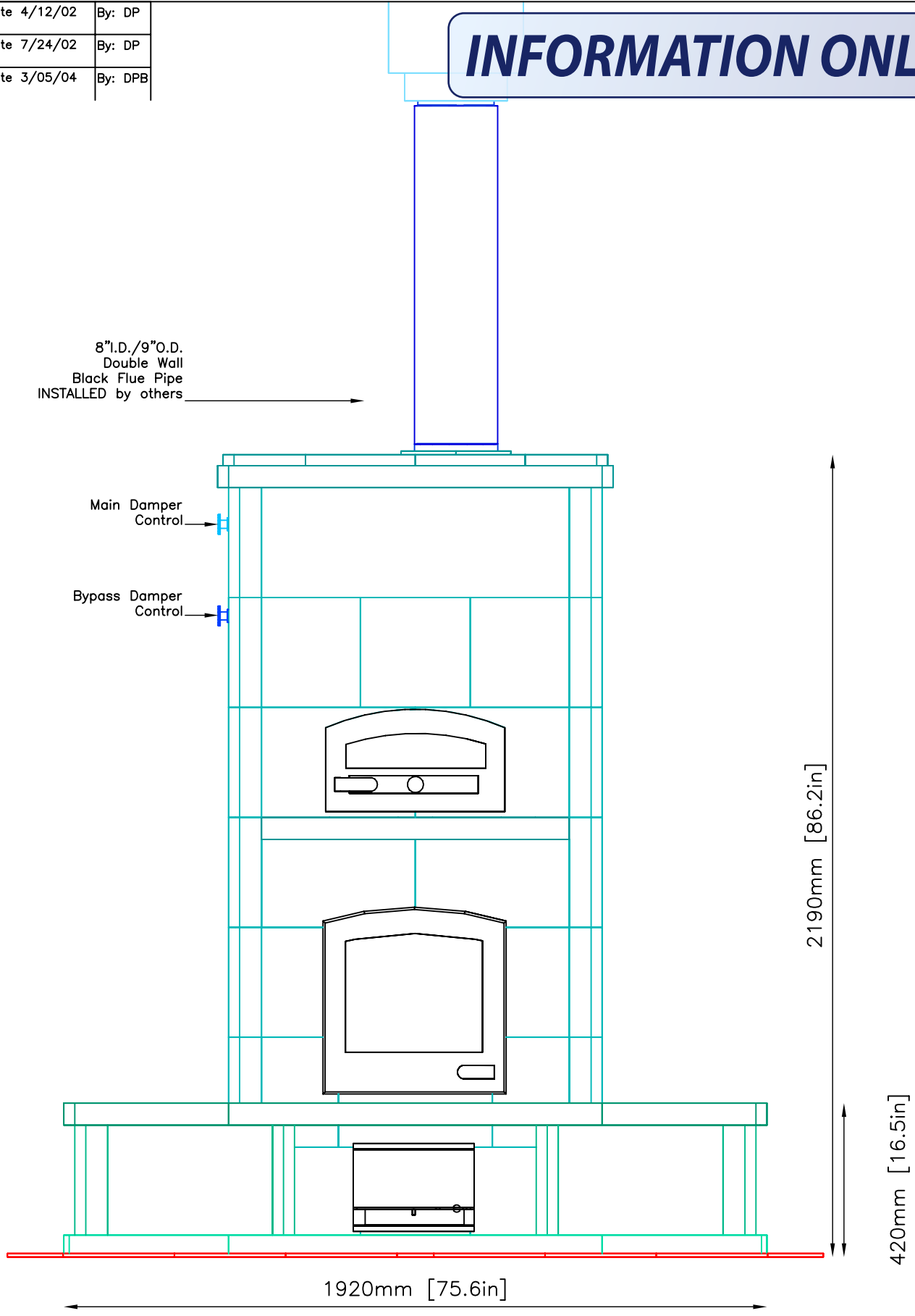

Revision: 1	Date 4/12/02	By: DP
Revision: 2	Date 7/24/02	By: DP

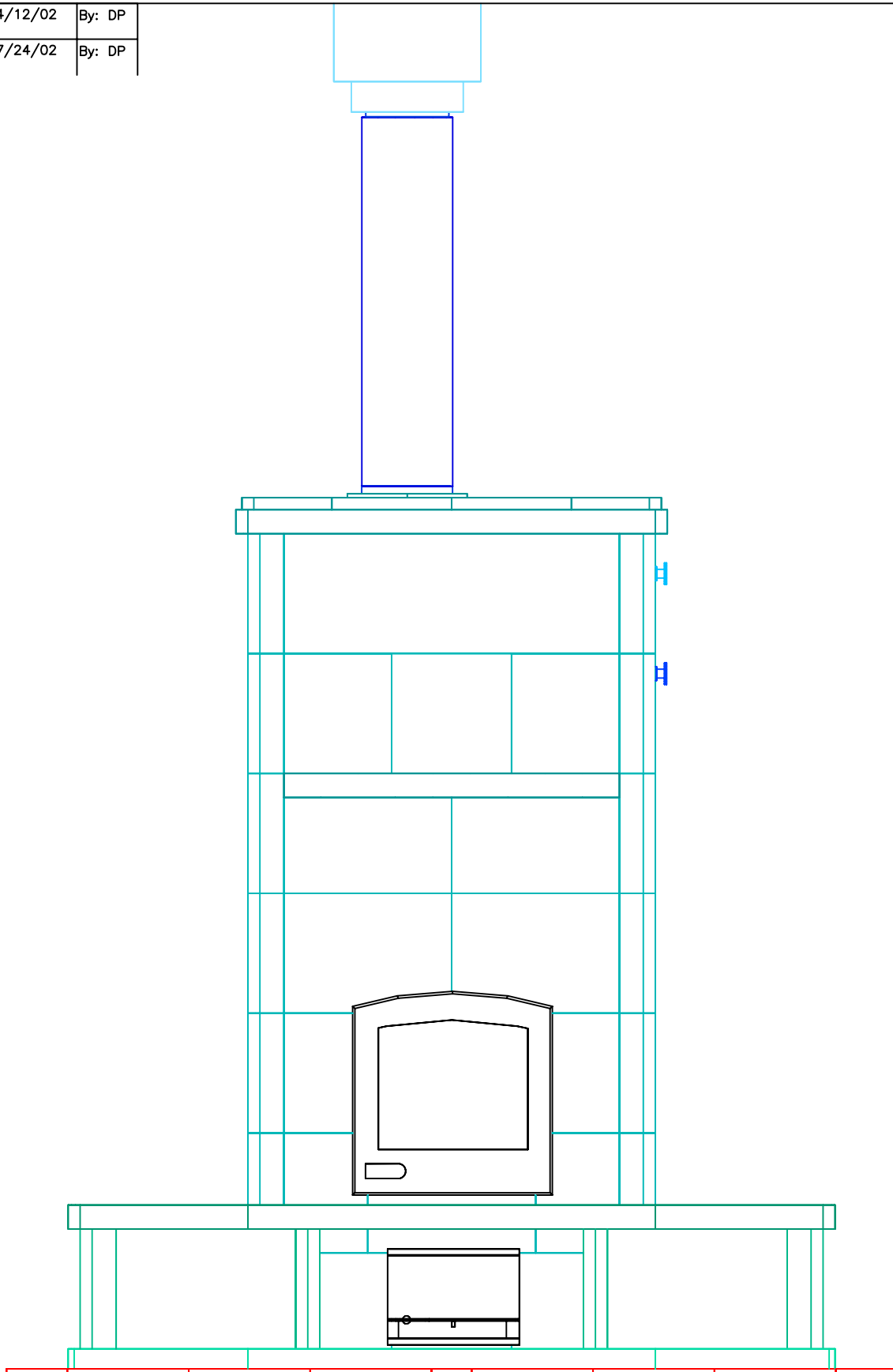

INFORMATION ONLY

TULIKIVI 	MID-ATLANTIC MASONRY HEAT McIntire Business Park Charlottesville, VA 22903 (434)979-9707 Fax 434-979-6416	PROJECT	FROSCHER	CONTRACT	5181	VIEW	BACK	PAGE 4
		MODEL	TTU2700/1	DRAWN BY	D.POWLEY	DATE	1/23/02	

Revision: 1	Date 4/12/02	By: DP
Revision: 2	Date 7/24/02	By: DP

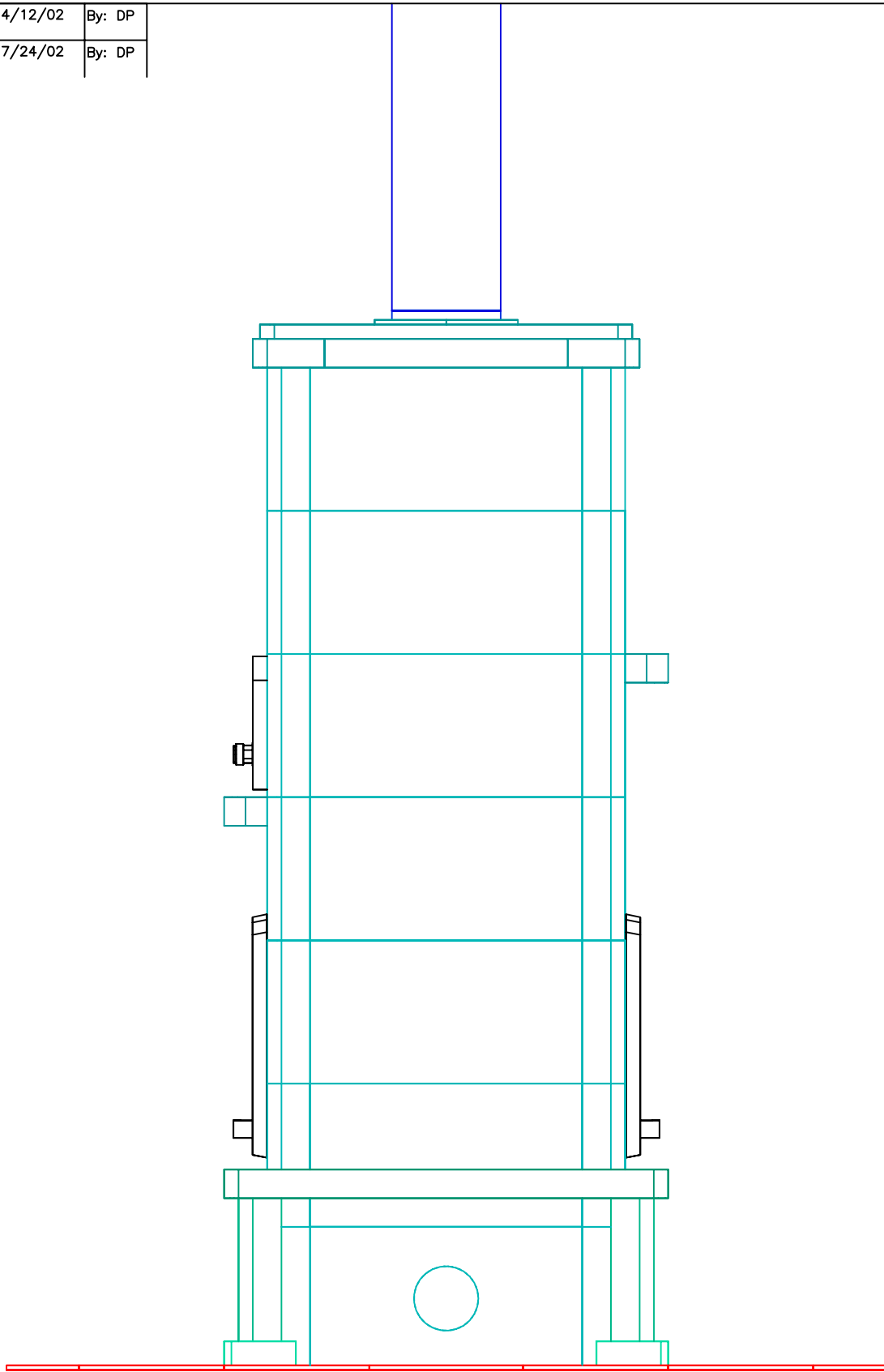

INFORMATION ONLY

INFORMATION ONLY

Revision: 1	Date 4/12/02	By: DP
Revision: 2	Date 7/24/02	By: DP

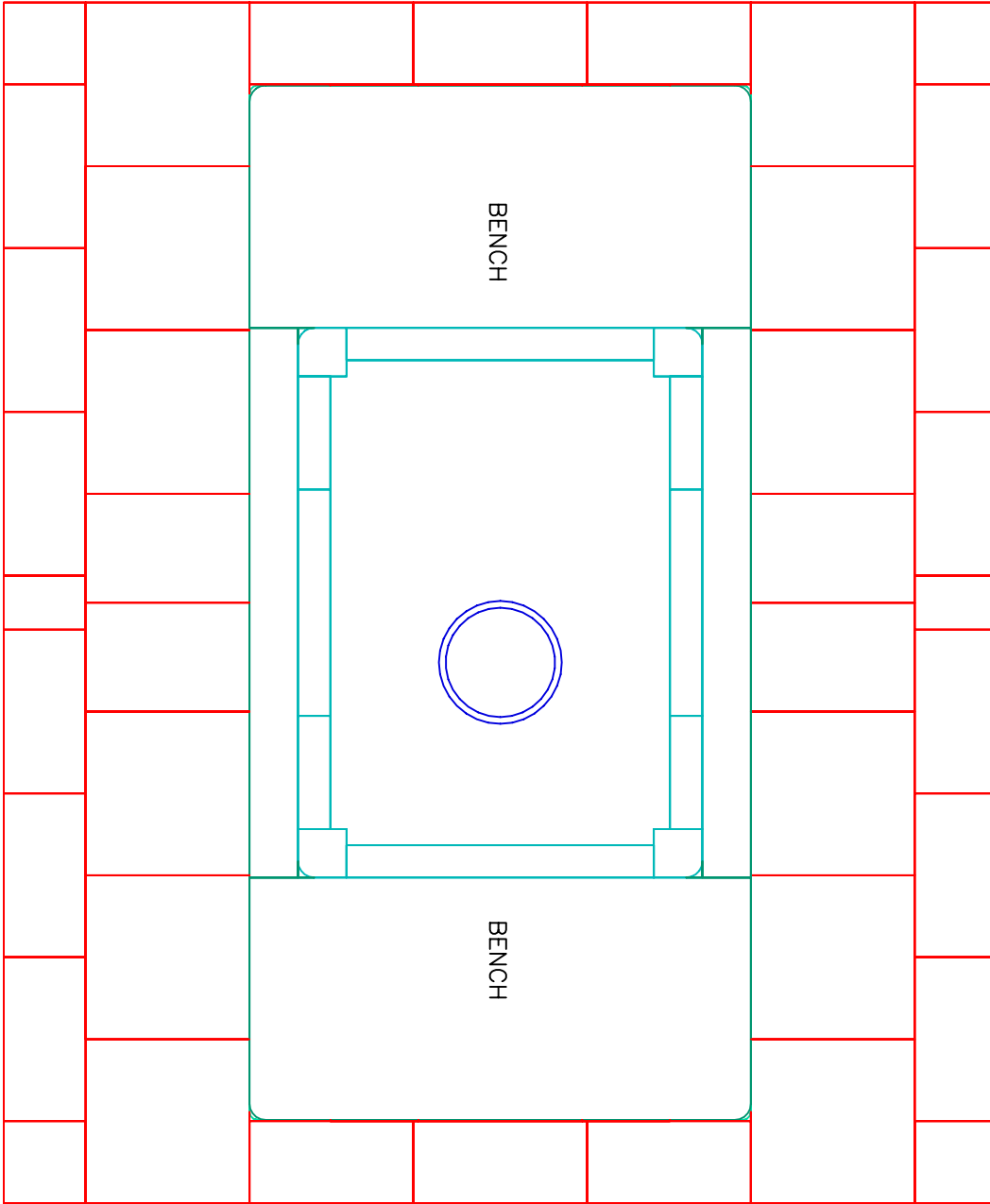

NOTE: HEARTH TILES INSTALLED BY OTHERS



MID-ATLANTIC MASONRY HEAT
McIntire Business Park
Charlottesville, VA 22903
(434)979-9707 Fax 434-979-6416

PROJECT FROSCHER
MODEL TTU2700/1

CONTRACT 5181
DRAWN BY D.POWLEY

VIEW PLAN
DATE 1/23/02

PAGE

6

Revision: 1	Date 4/12/02	By: DP
Revision: 2	Date 7/24/02	By: DP

CAPPING SLAB

Recommended Dimensions--Entire Hearth Area
72 1/2 inches X 87 1/2 inches

Minimum Dimensions--2" from Base of Unit
40 1/2 inches X 79 1/2 inches

Recommended Dimension

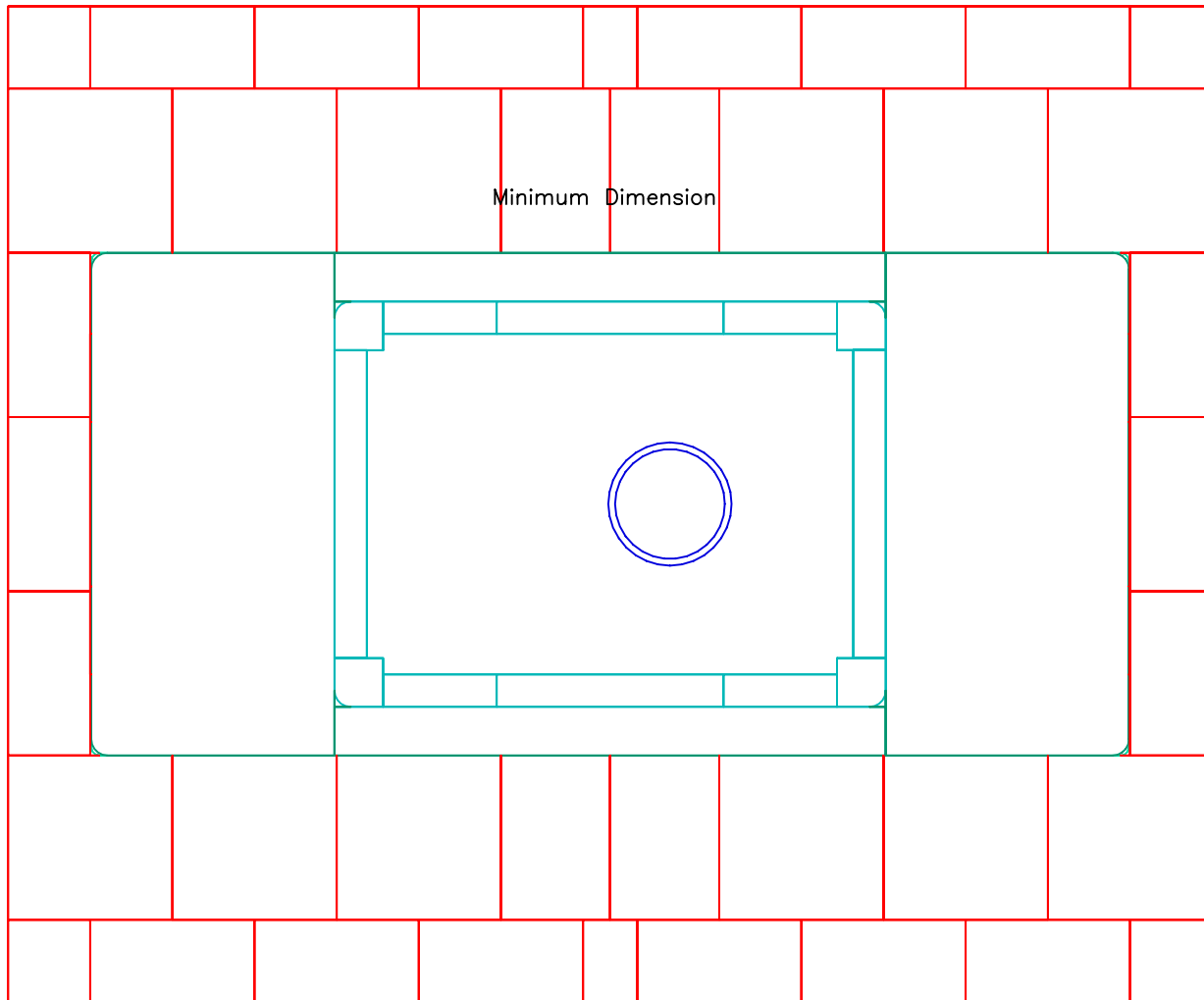

NOTE:
TOP OF CAPPING SLAB TO BE LEVEL WITH SUB-FLOOR
Tolerances: +/- 1/8" No additional cost to adjust slab
 +/- 1/4" \$150.00-\$200.00 additional cost to adjust slab
 +/- 1/2" \$500.00 additional cost to adjust slab

INFORMATION ONLY



MID-ATLANTIC MASONRY HEAT
McIntire Business Park
Charlottesville, VA 22903
(434)979-9707 Fax 434-979-6416

PROJECT FROSCHER
MODEL TTU2700/1

CONTRACT 5181
DRAWN BY D.POWLEY

VIEW SUPPORT
DATE 1/23/02

PAGE 7