

Sandblasted
Picture Stone
HP1M10L
(Moose)

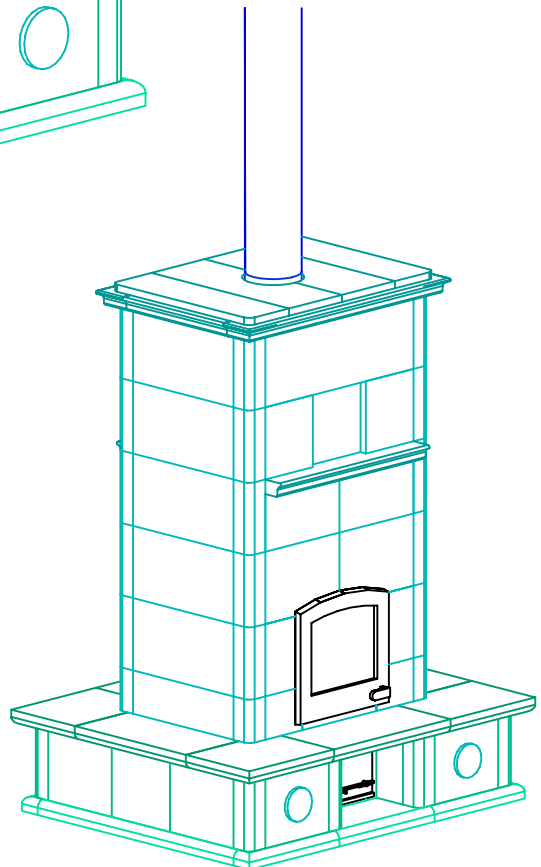

INFORMATION ONLY

NOTE: MINIMUM 6" non-combustible hearth extension required around base of fireplace. Hearth extension by others.



MID-ATLANTIC MASONRY HEAT
1229 Harris Street Suite 1
Charlottesville, VA 22903
(434)979-9709 Fax 434-979-6416

PROJECT PREISTER
MODEL TTU2700

CONTRACT 5624
DRAWN BY D.P.BYRAM

VIEW PERSPECTIVE
DATE 2/10/04

PAGE 1

INFORMATION ONLY

FRONT VIEW

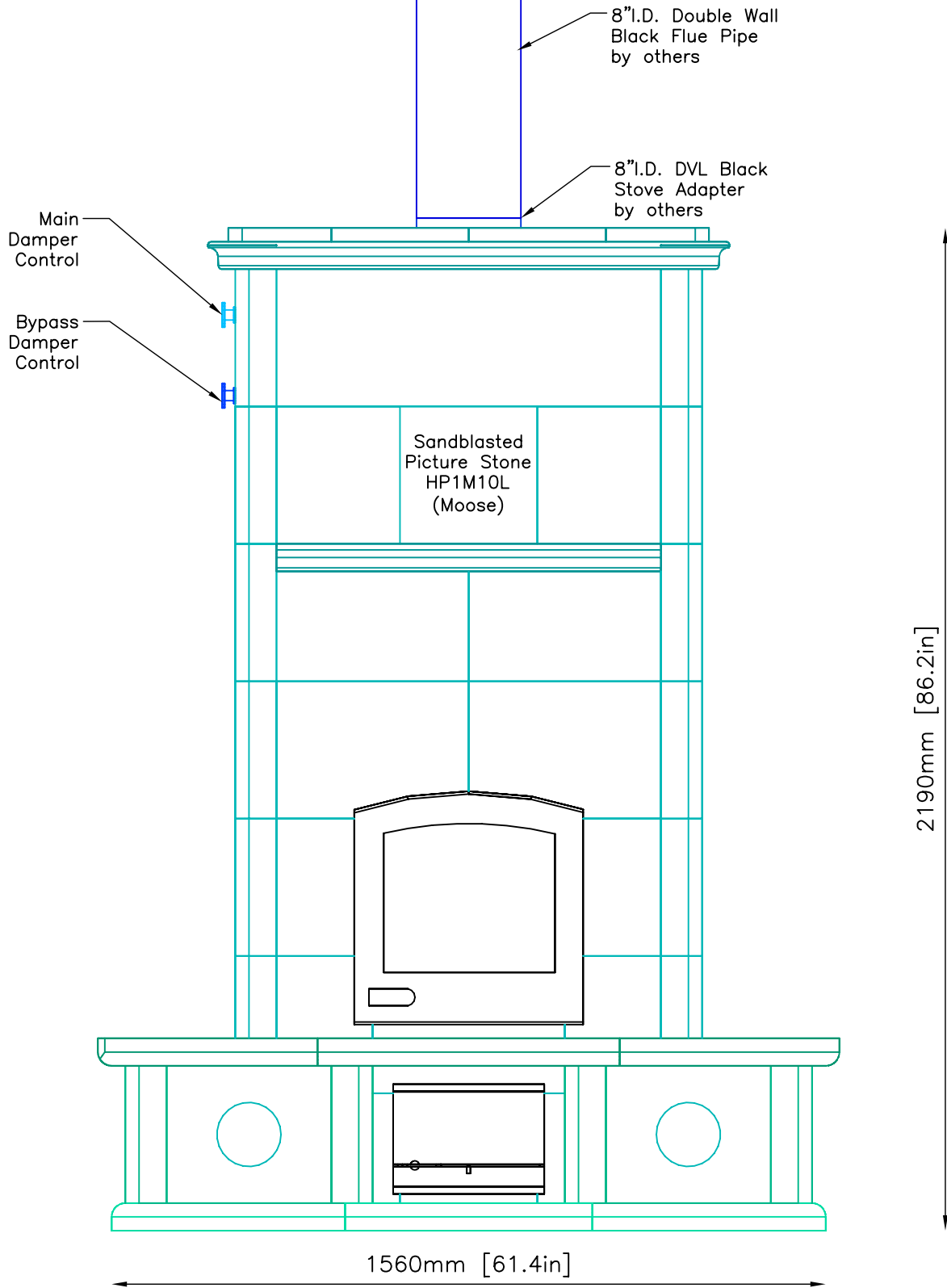

NOTE: MINIMUM 6" non-combustible hearth extension required around base of fireplace. Hearth extension by others.



MID-ATLANTIC MASONRY HEAT
 1229 Harris Street Suite 1
 Charlottesville, VA 22903
 (434)979-9709 Fax 434-979-6416

PROJECT PREISTER
 MODEL TTU2700

CONTRACT 5624
 DRAWN BY D.P.BYRAM

VIEW FRONT
 DATE 2/10/04

PAGE 2

SIDE VIEW

INFORMATION ONLY

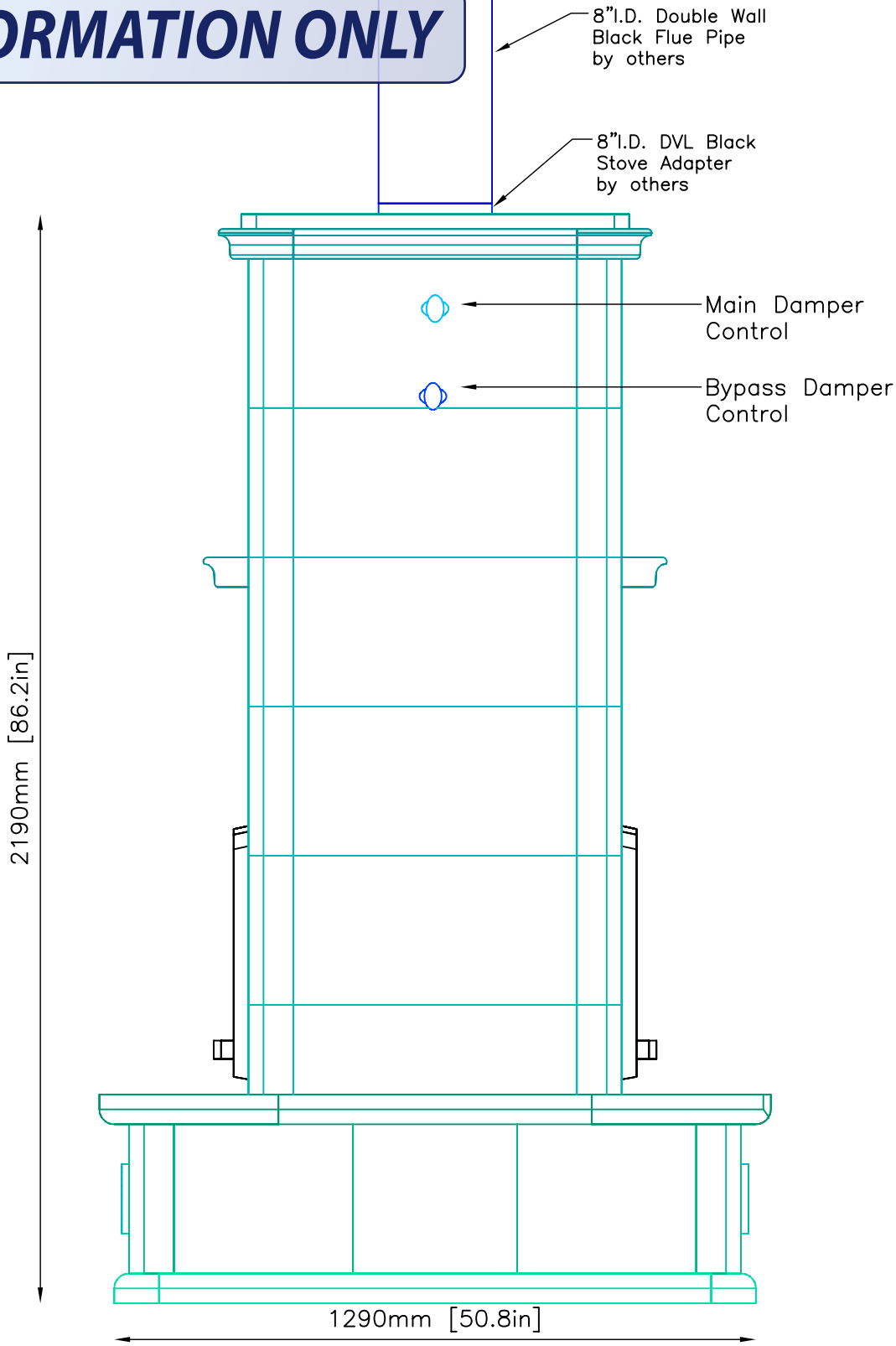

NOTE: MINIMUM 6" non-combustible hearth extension required around base of fireplace. Hearth extension by others.



MID-ATLANTIC MASONRY HEAT
 1229 Harris Street Suite 1
 Charlottesville, VA 22903
 (434)979-9709 Fax 434-979-6416

PROJECT PREISTER
 MODEL TTU2700

CONTRACT 5624
 DRAWN BY D.P.BYRAM

VIEW SIDE
 DATE 2/10/04

PAGE 3

PLAN VIEW

INFORMATION ONLY

NOTE: MINIMUM 6" non-combustible hearth extension required around base of fireplace. Hearth extension by others.

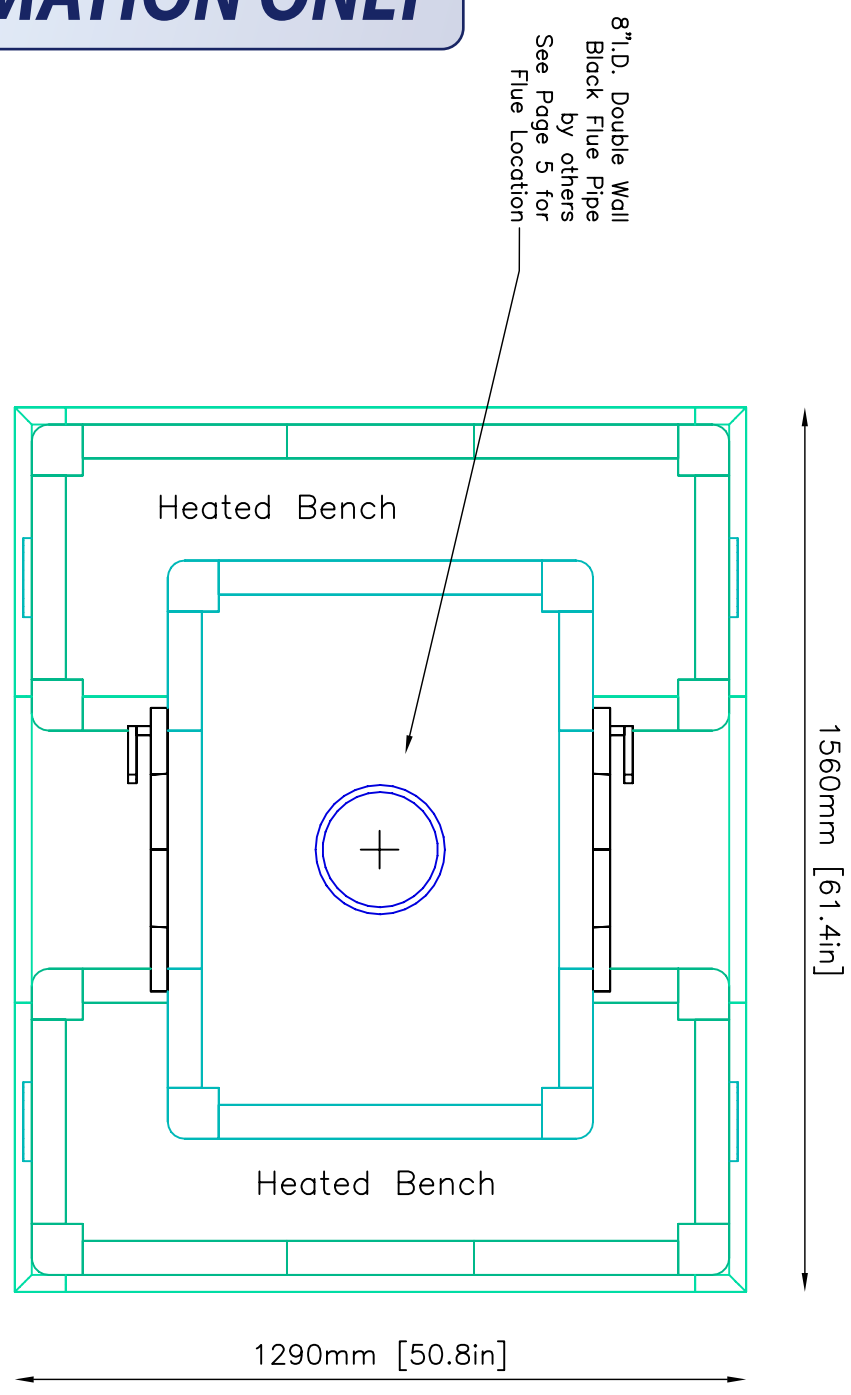

INFORMATION ONLY

FOUNDATION SLAB

Minimum 4" Thick Poured Concrete With Rebar 6"O.C.
 Minimum Dimensions--2" from Base of Unit

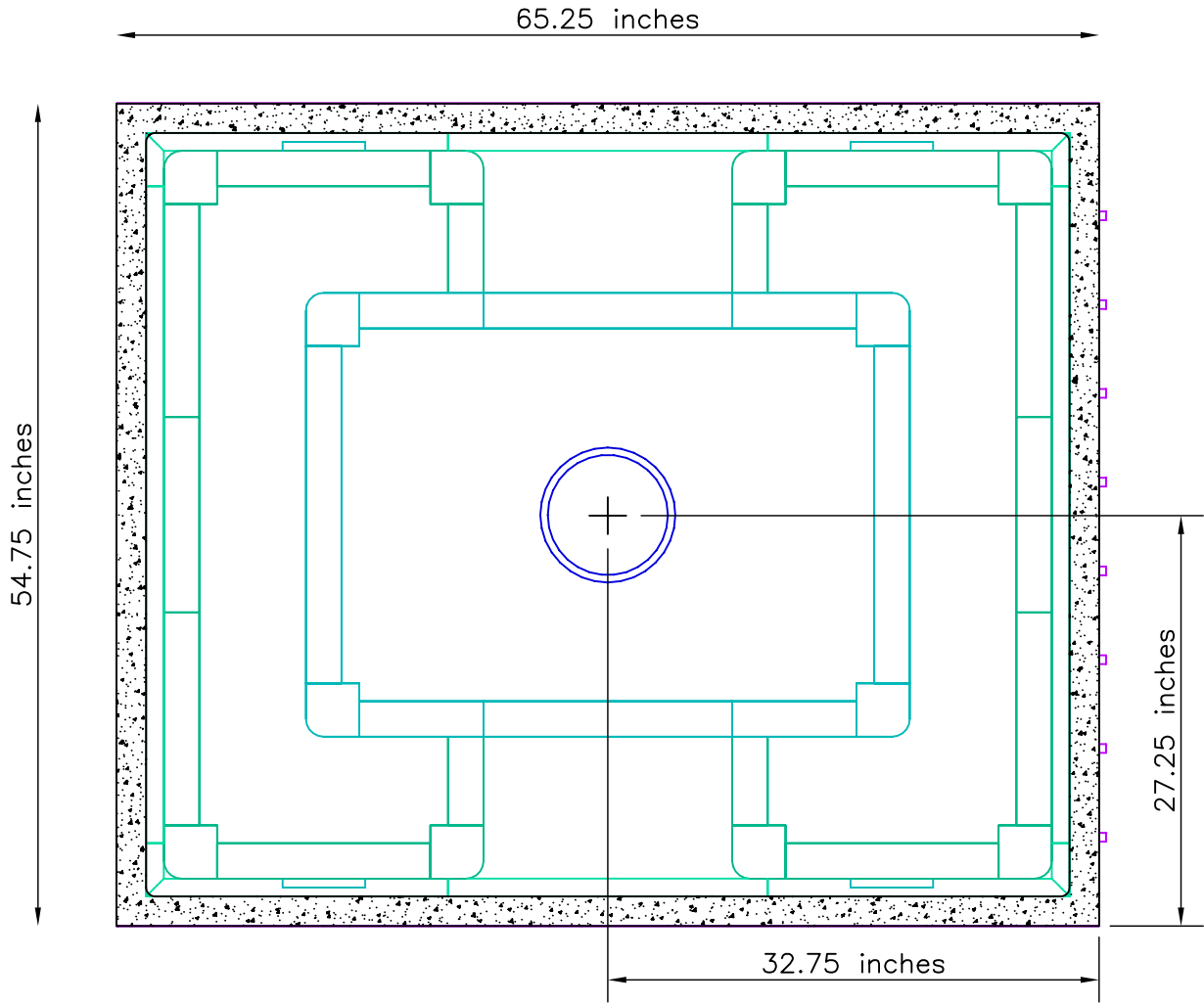

FLUE LOCATION:

27¹/₄" x 32³/₄" From Lower Right Corner of Foundation Slab to CENTER of Flue Pipe.

NOTE:

TOP OF FOUNDATION SLAB TO BE LEVEL AND FLUSH WITH SUB-FLOOR

- Tolerances: +/- 1/8" No addition cost to level slab
- +/- 1/4" \$150.00-\$200.00 additional cost to level slab
- +/- 1/2" \$500.00 additional cost to level slab

UNIT WEIGHT: 9500lbs.

Owner/Contractor is responsible for engineering Foundation Slab to support weight of fireplace.



MID-ATLANTIC MASONRY HEAT
 1229 Harris Street Suite 1
 Charlottesville, VA 22903
 (434)979-9709 Fax 434-979-6416

PROJECT PREISTER
 MODEL TTU2700

CONTRACT 5624
 DRAWN BY D.P.BYRAM

VIEW SUPPORT
 DATE 2/10/04

FOUNDATION SLAB:
 * MINIMUM 4" THICK
 WITH REBAR 6" O.C.
 * NONCOMBUSTIBLE
 CEMENT BOARD
 under foundation slab
 (NOT PLYWOOD)

INFORMATION ONLY

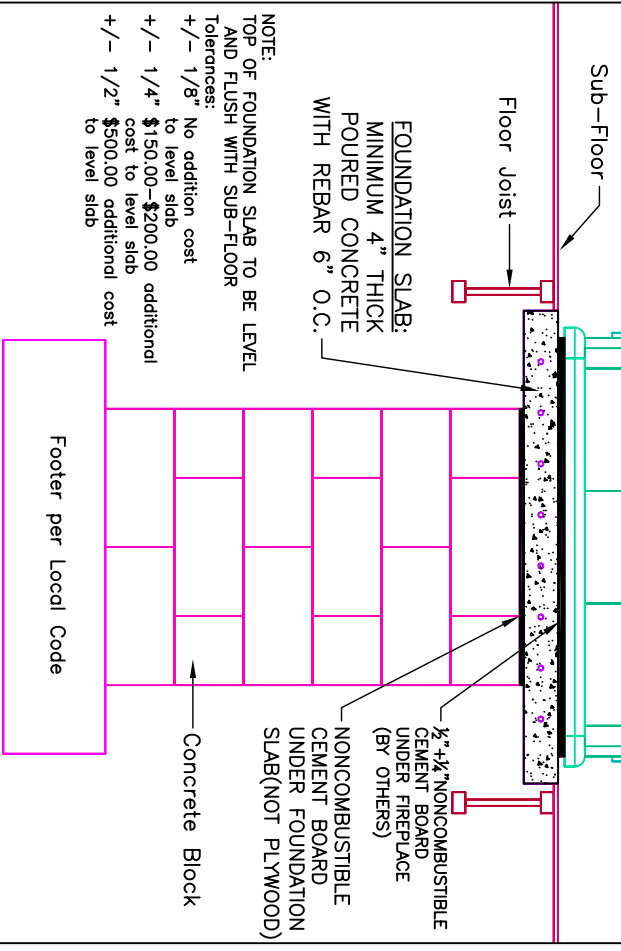

NOTE:
 TOP OF FOUNDATION SLAB TO BE LEVEL
 AND FLUSH WITH SUB-FLOOR
 Tolerances:
 +/- 1/8" No addition cost
 +/- 1/4" \$150.00-\$200.00 additional
 cost to level slab
 +/- 1/2" \$500.00 additional cost
 to level slab

UNIT WEIGHT: 9500lbs.
 Owner/Contractor is responsible for engineering Foundation Slab to support weight of fireplace.

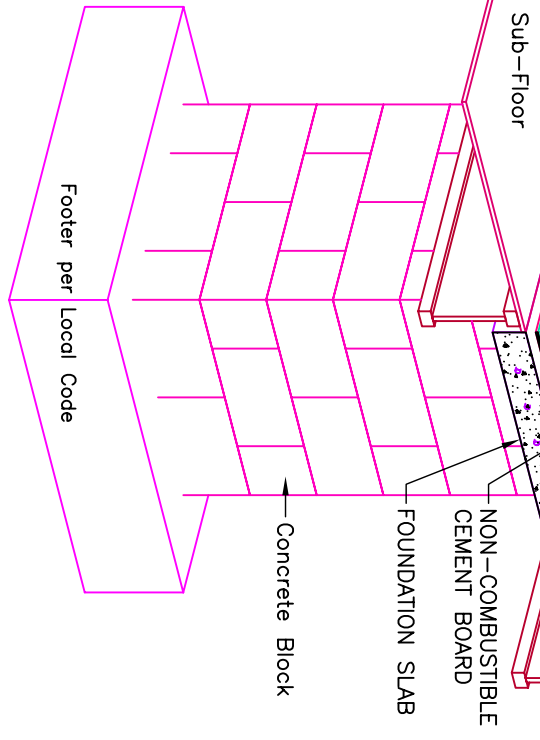

MID-ATLANTIC MASONRY HEAT
 McIntire Business Park
 Charlottesville, VA 22903
 (434)979-9709 Fax 434-979-6416

PROJECT PREISTER CONTRACT 5624
 MODEL TTU2700 DRAWN BY D.P.BYRAM

VIEW Foundation Slab
 DATE 2/10/04